

# ELECTRA

# ARF

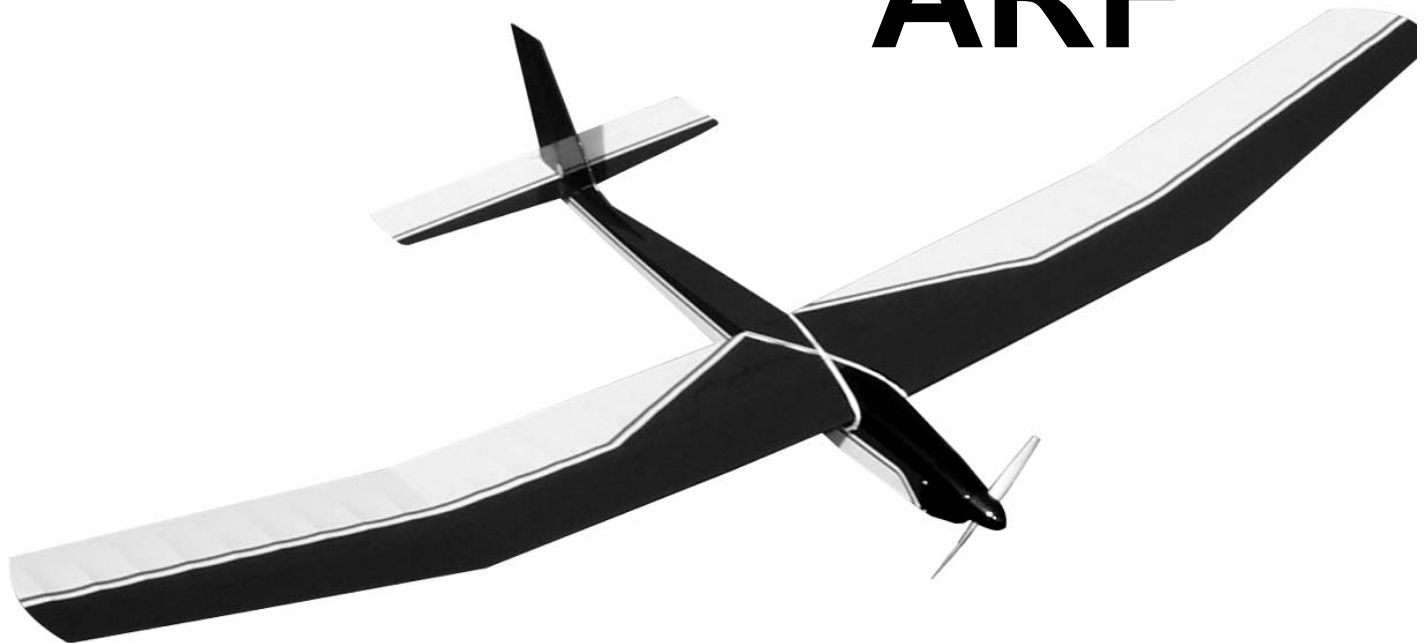

The **Electra ARF** sailplane was designed to be a gentle trainer for the beginning R/C modeler, yet possess an electric motor to so that it can be flown almost any where. **Electra ARF** is a very efficient machine, she reacts quickly to rising air ( called lift, or thermals) so that long flight times are easily achieved. **Electra ARF** can circle very tightly without falling off so stay in the thermal. . The **Electra ARF** has good penetration into the wind and can really “cruise” when desired. Before starting to build, read through these instructions and familiarize yourself with this booklet.

If this is your first electric plane, then you will need make a decision. Do you want to turn on the motor and fly till the battery runs out of power (2 channel radio required)? Or do you want to use an electric speed control that will let you stop and start the electric motor when you want too (3 to 4 channel radio required). Both methods are included in this booklet. You will need to do some soldering of wires but the Electra ARF will perform great either way you build it.

## WARNING

While this aircraft is an excellent first choice for novice pilots, a radio-controlled model is not a toy and is not intended for persons under 16 years old. Keep this kit out of the reach of younger children, as it contains parts that could be dangerous. A radio-controlled model is capable of causing serious bodily injury and property damage. It is the buyer's responsibility to build this kit correctly and to properly install the motor, radio, and all other equipment. Test and fly the finished model only in the presence and with the assistance of another experienced R/C flyer. the model must always be operated and flown using great care and common sense, as well as in accordance with the Safety Code of the Academy of Model Aeronautics (5151 Memorial Drive, Muncie, IN 47302), 1-800-435-9262). We suggest you join the AMA and become properly insured prior to flying this model. Also, consult with the AMA or your local hobby dealer to find an experienced instructor in your area. Per the Federal Communications Commission, you are required to use only those radio frequencies specified “for Model Aircraft”.

---

# CARL GOLDBERG PRODUCTS, LTD.

---

## Items needed to complete this kit. Necessary Tools and Supplies.

- 1 Radio Guidance system( 2 channel minimum required)
- 1 2oz. bottle CA glue
- 1 CA accelerator
- 1 30 minute epoxy
- 1 Box #64 Rubber bands.
- 1 1/4 x 8 x 12” CGP Foam Padding

### For Engine Power

7 cell 1500 to 1900 mAh battery

Optional: C-20 ESC or C-30 Mini ESC speed control (Great Planes MFG.)

- Roll of waxed Paper
- Modeling Knife and Single Edge Razor Blade
- Pins
- Electric Drill
- Various Drill Bit
- Small Screwdriver
- Masking Tape
- 30-60 Degree x 6” Triangle
- Pencil

### Selecting Radio Control Equipment

Radio sets are battery powered with either dry cells or the more reliable, rechargeable nickel-cadmium (ni-cad) batteries. Although ni-cad powered units are more expensive, the cost of routinely replacing worn out batteries may be much higher in the long run. Many of the radio systems now available feature “servo reversing” switches which allow you to reverse the response of the servo. This simplifies radio installation and is worth considering. Exponential or dual rates are popular features which, if used properly, can help smooth out the flight of a sensitive model. Your local hobby dealer should be able to help you select the proper radio for your needs and skill level. And be sure to get a system designed for aircraft, as only certain frequencies are available for model aircraft.

#### Limited Warranty

Carl Goldberg Products takes pride in the care and attention given to the manufacture of components for its model airplane kits. The company warrants replacement of any materials found to be defective for their intended use, **prior to their use in construction of the aircraft**, provided the buyers requests such replacement within a 90 day period from the date of purchase and provided the defective part is returned, if so requested by the company.

No other warranty, expressed or implied, is made by the company with respect to this kit. The buyer hereby assumes full responsibility for the risk and all liability for personal or property damage or injury arising out of the buyer’s use of the components of this kit.

### Important Information

Covering coming loose is not COVERED UNDER WARRANTY. Due to temperature changes the plane may develop some wrinkles in the covering that you will need to remove with an iron. Be sure to seal the edges down first so that you do not cause the covering to shrink and leave exposed areas of wood. Please inspect the plane before beginning to assemble to make sure you are happy with it. After assembly has begun you cannot return the kit. If you find a problem before beginning to assemble the plane you must contact us, please do not return it to the dealer.

## Using This Instruction Manual

Before you start gluing take some time to look through this entire instruction booklet. It is designed to guide you through the construction process step by step, so build in the order given in this book. Radio selection and installation, balancing and flying the model are all covered.

Like a full-size airplane, the Electra ARF is built from basic structures (stabilizer, fin, wing, etc.), which are then assembled into the complete airplane.

Special procedures or comments will usually be explained before a step, so you will be prepared. If a step begins with a statement like "Note," "Warning," or "Important," it is a good idea to read through the step before doing it.

A check-off box appears at the beginning of each step. Check these boxes as you build, so you can tell at a glance what steps you have completed.

Some of the instructions deal with general procedures. Boxes are not needed for these sections.

## Preparing For Assembly

You will need a area approximately 18" x 80" in order to build the **Electra ARF**. Place a sheet of waxed paper or plastic kitchen wrap over the work area to prevent CA from sticking to your table.

## Construction Tips

If you have never assembled a built-up model before, the following tips will prove helpful.

**IMPORTANT: ALWAYS READ A FEW STEPS AHEAD.** This will alert you to coming instructions and will help you plan accordingly.

You may find it convenient to empty all of the small parts from the hardware bags into a common container, such as a margarine tub. This will help you find items quickly.

When drilling any 1/16" holes in balsa, you may find it easier to twist the drill between your thumb and index finger. This procedure allows more control in positioning the drill on the center mark.

## Parts Identification

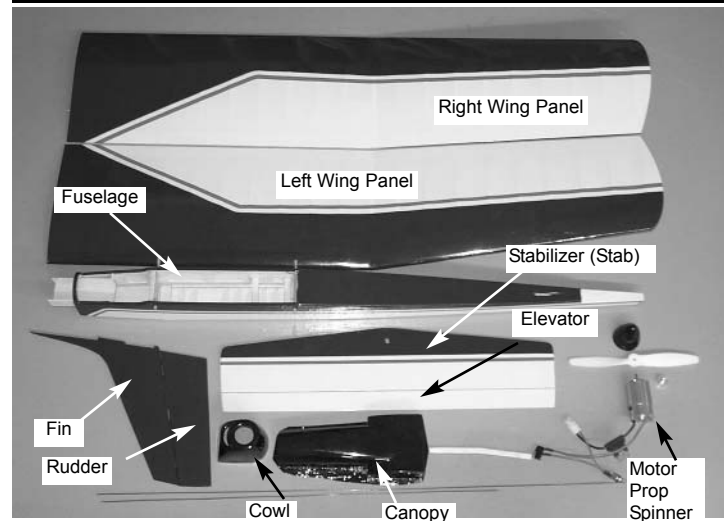

Additional Items included in the kit:

- (2) Control Horns
- (2) Control Horn Bases
- (4) 2-56 x 1/2" Pan Head Screw
- (2) Wire
- (2) Snap Links
- (2) Snap Link Retainers
- (2) Pushrod Connectors
- (1) Wood wing Joiner
- (1) Prop hub assembly

## Wing Assembly



1.  Collect the following parts:
  - (1) Left wing panel
  - (1) Right wing panel
  - (1) Wing Joiner
2.  Holding the wing joiner with the angle cut facing up, insert them into the joiner pockets in both wing halves. The joiners should fit easily in the pockets and the wing halves should meet in the middle, with the wing dihedral forming a broad "V".
3.  Working on a protected surface, and with a paper towel handy for cleaning fingers, **THOROUGHLY** mix 1-2 large (soup) spoons each from bottle A and bottle B of epoxy. (Use equal amount of each part and mix with a stick in a plastic or paper cup, or on a sheet of waxed paper.)

- Spread the epoxy in the joiner pockets and in the dowel hole and spread a thin layer of epoxy along one side of the entire center joint area. **Immediately proceed to the next step.**

- Working rapidly, so that the epoxy does not set before you are finished, slide the wing joiner into one wing pocket.
- Then slide the wing halves together until they are touching. Make sure the rear dowel slides into the dowel hole.

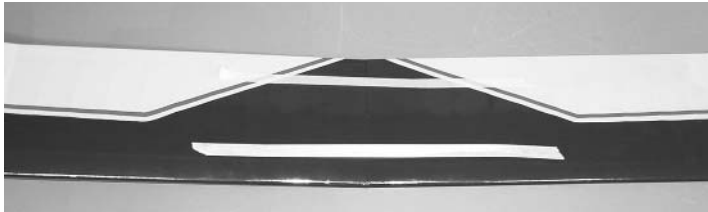

- With masking tape, tape the wing halves together at the trailing edge and close to the leading edge, as shown. This will help keep the wing from twisting.
- Place additional tape at several locations across the center seam of the wing, so that the halves stay firmly together while the epoxy sets.
- Allow the epoxy to dry thoroughly.

**Note: Both outer wing tips should be about 6-3/8" off the table top.**



- Collect the following parts:

- (1) Fuselage
- (1) Stabilizer
- (1) Fin
- (2) Control Horn
- (4) Screws

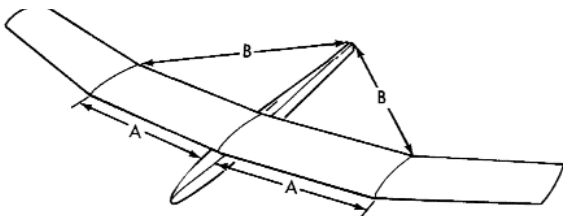

- Mount the wing on the fuselage using the rubber bands provided
- Measure carefully from the fuse sides out to the polyhedral breaks (arrows 'A') to be sure that the wing is centered.
- Now measure from the polyhedral to the back end of the fuselage (arrow 'B') to make sure wing is square to the fuselage.
- Mark the wing and the fuselage with matching line-up points.

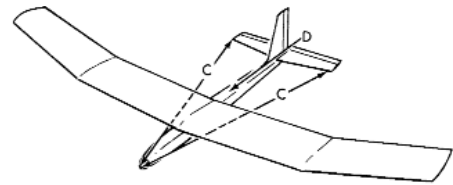

- Trial fit the stab in place on the fuselage. Place a piece of masking tape across the fuselage in front of where the stab mounts.
- Measure across the fuselage and mark the center.
- Place two strips of masking tape along the edge of the stab, next to the both outer stab tips and above the hinge line.
- Using a T-square or triangle, draw a line from the front center point of the stab to the rear hinge line.
- Measure 9-1/2" out ("B") from each side of the centerline and make a mark on the masking tape.
- Measure from the marks on the stab to the polyhedral breaks on the wing adjust as necessary to line up with wing.
- Mark the stab and fuse with matching line-up points.

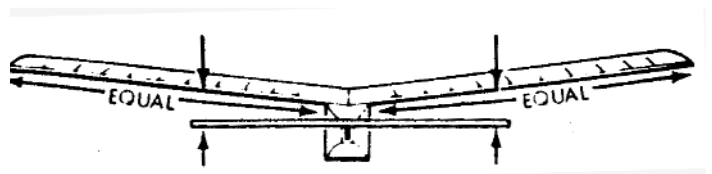

- Make sure the stab is level (parallel) with the wing and insert paper strip shims, if necessary.

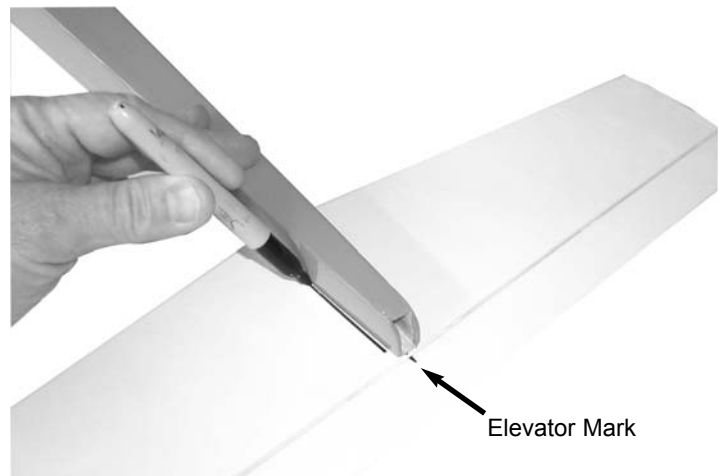

- When satisfied with the alignment of the stab, temporarily tape securely in place.
- Turn over the plane and mark the area on the bottom of the stab where it rests on the fuse.

- Remove the stab from the fuse and, working 1/4" inside the drawn lines, carefully remove the covering from the bottom of the stab. BE CAREFUL TO AVOID CUTTING THE WOOD
  - Mark the center of the elevator and remove the elevator from the stab
- 9.
- Spread epoxy on both the bottom of the stab and the stab platform of the fuse.
  - Replace the stab on the platform and, after again checking the alignment of the stab to the wing, allow the epoxy to dry thoroughly.



- 4.
- Place the control horn on the bottom of the elevator over the center mark you made.
  - Mark the screw hole locations.
  - Drill the holes for the control horn.
  - Using two machine screws, secure the control horn to the elevator.

## Fin Assembly

- 1.
- Collect the following items:
    - (1) Fin
    - (1) fuselage
    - (1) Control Horn
    - (2) Screws



- 4.
- With the rudder sitting on the fin, as shown, place the horn on the bottom of the rudder.
  - Mark the holes.
  - Drill the holes for the control horn.
  - Again using two machine screws, secure the control horn to the rudder.

- Remove the rudder from the fin and set to the side.

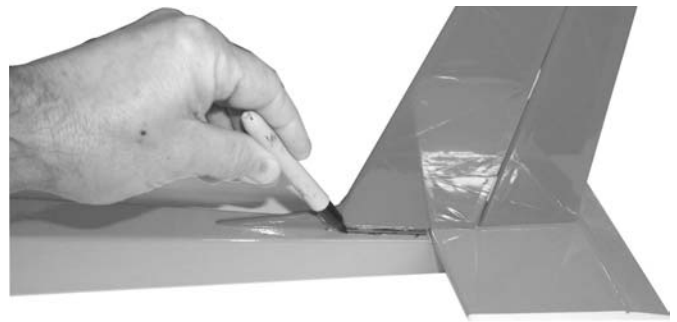

- 2.
- Slide the fin mounting posts into the top of the stab.
  - Check the fit. The fin should fit easily into each slot and should stand upright by itself. Enlarge the holes, if necessary.
- 3.
- As shown above, mark where the fin touches the fuselage.

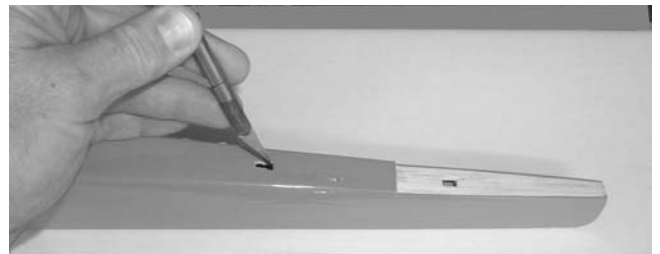

- **TAKING CARE NOT TO CUT INTO THE WOOD STRUCTURE UNDERNEATH**, and working inside the drawn lines, carefully remove the covering where the fin mounts on the fuse and stab.

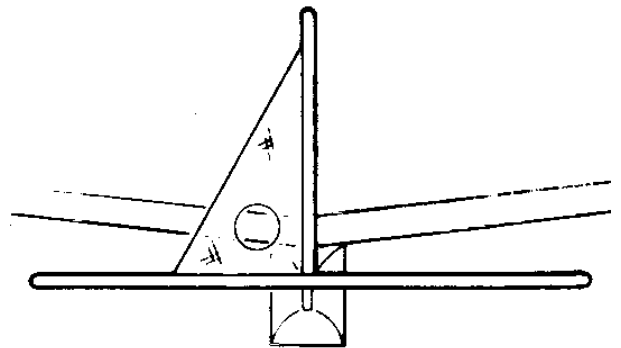

- 5.
- Remount the fin on the fuse and, using a 90° triangle, make sure the fin is perpendicular to the stab.
  - When satisfied with the fit, remove fin and mix up a couple of spoonfuls of epoxy.
  - Apply a **THIN**, even coat of epoxy on the bottom of the fin and along both sides of the fin mounting posts. Avoid too much glue, which will squeeze out from underneath the fin.
  - Mount the fin on the fuse and place the triangle against the fin to make sure it is perpendicular.

- Use masking tape to secure the fin and triangle in position until the epoxy is thoroughly dry. Make sure not to glue the triangle!

# Mounting Rudder and Elevator

- Collect the following items:
  - (1) Rudder with control horn
  - (1) fuselage
  - (1) Elevator with control horn
  - (2) long wire with "Z" bends
  - (7) Hinges

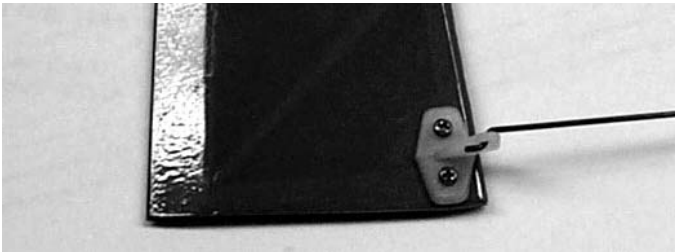

- Remount the the hinges back into the rudder. Place one of the long wires onto the control horn using the "Z" bend.

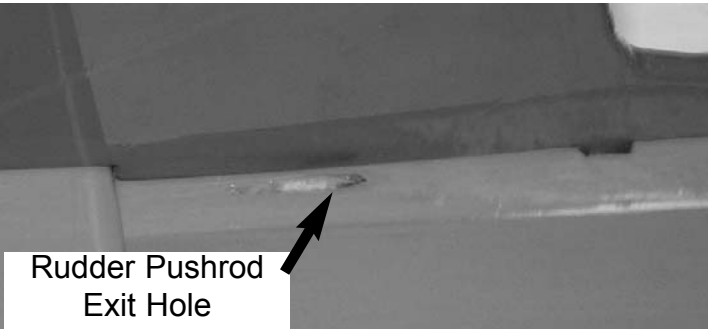

- Insert the wire into the hole on the top of the fuselage and slide the wire down into the tube.
- Insert the hinges into the slots of the fin.

**Hint:** Place a pin in the center of the hinge so that the hinge will insert half way into the fin and the rudder.

- When satisfied with the fit then place one drop of **thin** CA glue on each side of all the hinges. Remove the pins and set aside for about 10 minutes.
- Repeat this process for the elevator. **DO NOT FORGET THE PUSH ROD WIRE.**

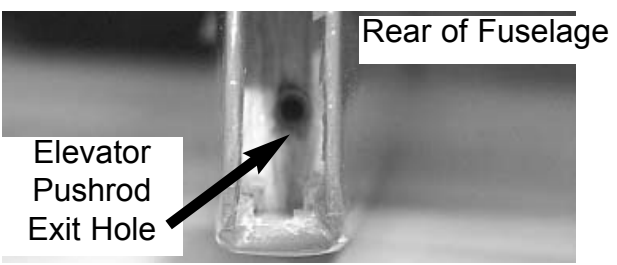

# Installing the Radio

- Collect the following items:
  - (2) Servos with screws(Supplied with Radio)
  - (2) Servo Arms
  - (1) fuselage
  - (2) Pushrod connector
  - (2) Nylon Snap Nut
  - (2) Set Screws



- Mount your servos as shown above.

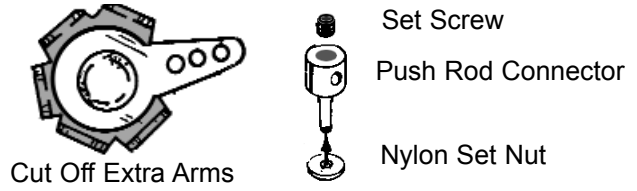

- Insert the Pushrod connector through the hole on the servo arm and install the snap nut on the bottom as shown above.
- Slide the rudder pushrod wire through the hole and mount the servo arm on the rudder servo.
 

**Hint:** Do not screw the servo arm on the servo at this time.

  - Repeat steps 2 and 3 for the elevator servo arm.
- Place tape on both the elevator and the rudder to hold them both straight and level to the fin and stabilizer.

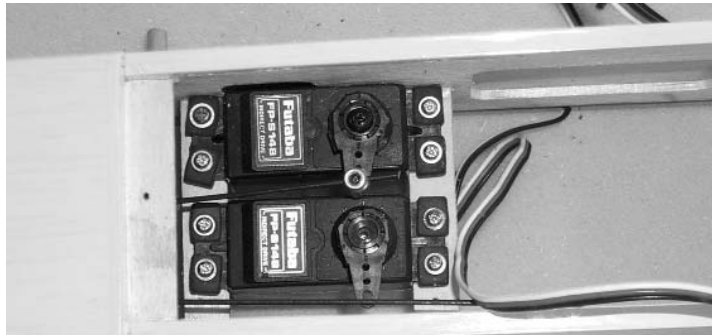

- Making sure that the servo arms are as shown above. Insert the set screw into the top of the pushrod connector and tighten onto wire.
- Place the receiver in the front of the servos. Plug the servos into the receiver as shown in your radio instructions.

# Installing Motor Switch

**Note: We recommend that you use a electric speed control for your electra. You will get better performance and have more control over the airplane while flying.**

The following steps are for 2 channel operation. This will allow you to run the motor till the battery runs out of power.



1.  Your Electra ARF comes with a 20 amp fuse in the wire that runs from the battery plug and the motor. This fuse will prevent the motor from being damaged by any obstruction that might stop the propeller from turning.

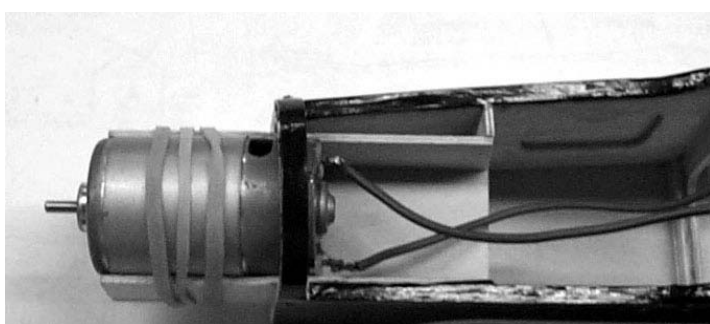

2.  Slide the motor wires from the front through the forward former.  
 Press the motor down into the motor tray. Wrap 2 rubber bands around the motor.

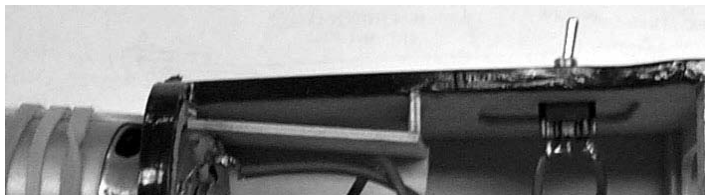

3.  Drill a hole into the side of the fuselage and mount the motor switch.

**NOTE: If you will launch the plane using your right hand, mount the motor switch on the left side of the fuselage.**



4.  Carefully cut through the side of the fuselage and mount your receiver switch as shown.  
 Plug the switch into the receiver as shown in your radio instructions.  
 Wrap the receiver and the battery pack in foam and place in the nose. Plug the battery into the switch.

The motor system is designed with a safety fuse to protect the system from excessive motor loads. During motor operation, if the propeller should hit an object, the sudden surge of battery current will blow the fuse and prevent motor/battery burn out or other damage. Use only a 15 or 20 AMP fuse to connect the fuse terminals. **DO NOT BY-PASS THE FUSE** or directly connect the terminals together. If using another brand of motor, make sure it is equipped with a fuse. If it isn't, ask your hobby dealer how to install one. **DO NOT OPERATE YOUR ELECTRA MOTOR SYSTEM WITHOUT A FUSE!**

Operate motor **ONLY** with propeller securely installed. Without propeller, the motor may "over-rev" and be permanently damaged.

Make sure that the amount of movement you have for both the elevator and the rudder does not exceed the following measurements for the first flight.

Elevator      5/16" up and down

Rudder        1" right and left

The following steps are for 3 channel operation. This will allow you to control the motor till the battery runs out of power. This also alleviates the need for a separate receiver battery pack.

We will be showing the installation of Great Planes ElectriFly C-30 Mini ESC. Follow the instructions that come with your speed control to assure proper installation.



1.  Remove both wires from the back of the motor.
- Follow the instructions that came with your particular speed control at this time.

**IMPORTANT!**  
**PLEASE READ THIS SECTION**  
**FAILURE TO FOLLOW THESE PRECAUTIONS CAN LEAD TO SERIOUS PERSONAL INJURY TO YOURSELF OR OTHERS, AND CAN RESULT IN PROPERTY DAMAGE.**

**SAFETY PRECAUTIONS:**

**WHEN OPERATING THE MOTOR:**

- ALWAYS wear eye protection!
- KEEP AWAY from spectators!
- KEEP AWAY FROM CHILDREN. DO NOT allow children to operate without adult supervision.
- PROPELLER must be properly installed to prevent excessive RPMs.
- MOTOR BATTERY SHOULD BE DISCONNECTED except when ready to fly or when necessary for checking electrical operation and maintenance.
- OPERATE MOTOR ONLY WITH PROPELLER INSTALLED.

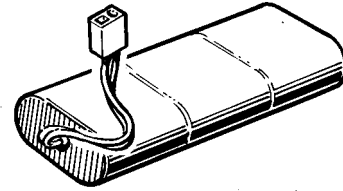

**BATTERY HAZARD!**

The battery size used to power the **Electra ARF** motor stores a lot of electrical energy. Be careful to prevent shorting it out. A dead short can cause a powerful surge of electrical current which can ruin your battery and generate enough heat to start a fire. It can also cause burns to you and others.

The motor/battery system used to power the **Electra ARF** is very powerful. To avoid injury, always disconnect and remove the motor battery when you are not flying the airplane.

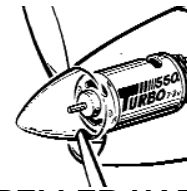

**PROPELLER HAZARD!**

When switched on, the motor instantly reaches full power and maximum propeller RPM. An electric motor pulls more battery energy as its work load is increased. This means, for example, that if the prop hits your hand, it not only smacks you at high speed, it also draws more battery power to overcome the added load. Therefore, the impact force and injury are increased. It is extremely important that you are aware of these dangers and take precautions to prevent accidentally switching on the motor. This is especially important while working on the model or when storing it. Always remove the battery when storing the model and make sure it is kept away from children and anyone else who is not familiar with its safe operation.

**REMEMBER: ALWAYS DISCONNECT AND REMOVE BATTERY WHEN WORKING ON THE MODEL, TRANSPORTING, OR STORING IT. DO NOT LEAVE THE BATTERY CONNECTED EXCEPT WHEN FLYING!**

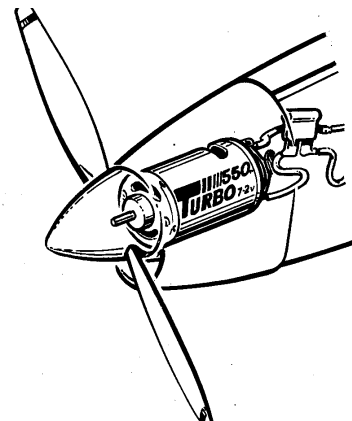



# Radio Layout

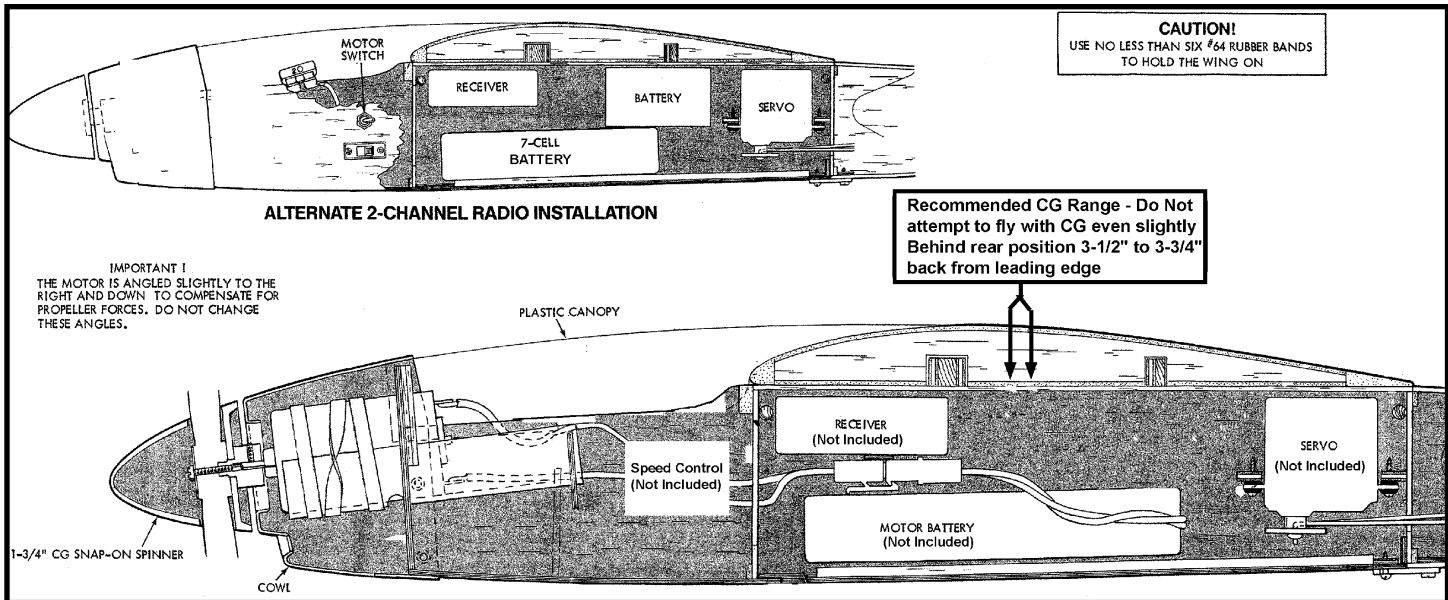

## Installing Cowl and Prop

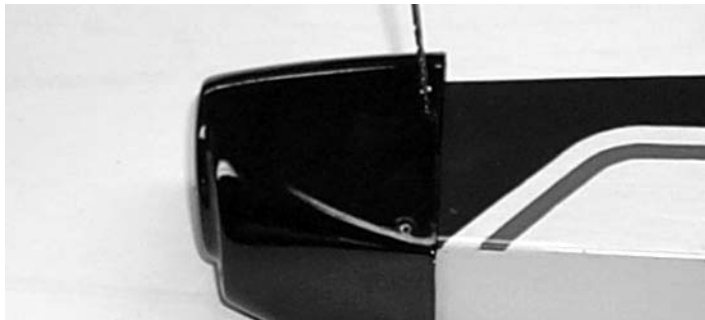

- Place the cowl on the nose of the fuselage. Try to keep the bottom of the cowl as close to the bottom of the fuselage.
  - Using a 1/16" drill, make 2 holes on both sides of the cowl. Try to drill into the side of the front former.



- Using #2 x 3/8" screw, mount the cowl on the fuselage.

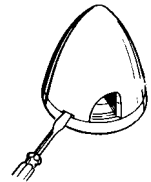
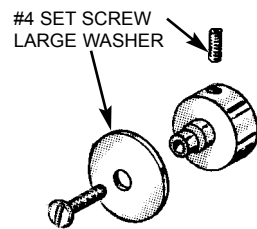

- Thread a #4 socket set screw in the prop mount and turn a few times.
  - Open the spinner supplied by carefully inserting a small screwdriver straight into each of the slots. **DO NOT TWIST! JUST PRY OPEN.**

NOTE: Carefully read the instructions included with your spinner.

- When the spinner backplate has been removed, place it on the propeller mount.

DO NOT OVER TIGHTEN

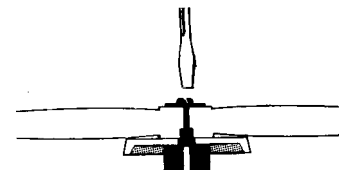
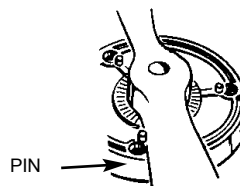

- Place the propeller on top of the backplate so that it lines up with the pin, as shown above.
  - Place a large washer on top of the prop and then install, using a #4 x 1/2" machine screw. **CAUTION: DO NOT OVER-TIGHTEN**, as this may cause the threads to strip out.

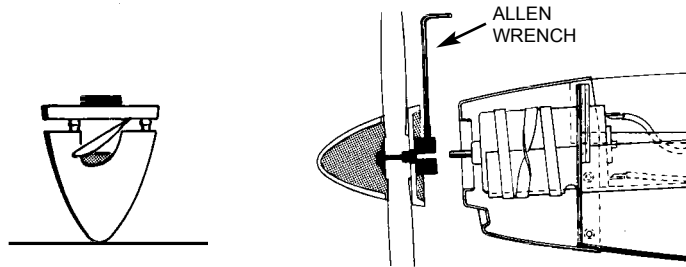

**Warning: A spinning propeller can cause injury. Wear safety glasses and operate away from spectators.**

5.  Align the spinner cone with the prop/backplate and press pins firmly into the holes. One way to do this is to have the cone pointing downward on a table and press until all pins are seated.
- Install the prop/spinner assembly on the motor shaft and securely tighten the set screw with a .050 Allen wrench.

## Canopy and Battery Hatch

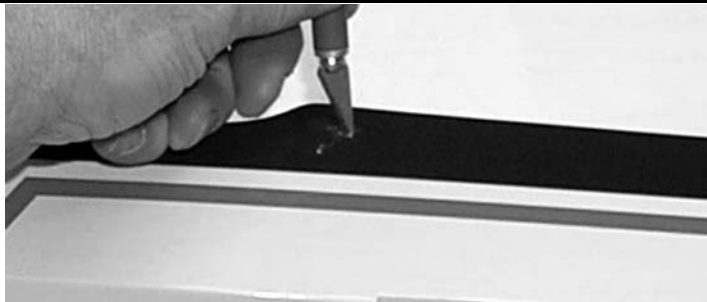

1.  Find the holes on the side of the fuselage and cut a "X" pattern in the covering over the holes.
- You will find two holes on each side of the fuselage.

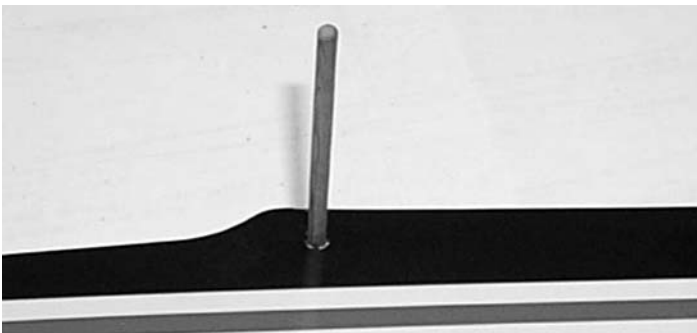

2.  Insert a dowel into the front and back hole till equal amounts are showing on both sides of the fuselage.
- When satisfied glue the dowels in place.

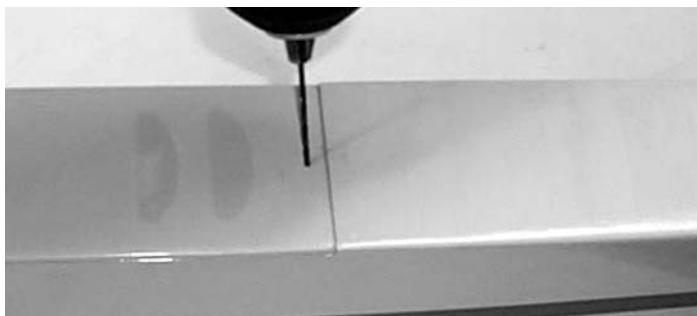

3.  Insert the battery hatch into the bottom of the fuselage. The tongue on the hatch goes forward.
- In the rear of the hatch drill a 1/16" hole in the middle.
- Screw the hatch to the fuselage by using a #2 x 3/8" screw.

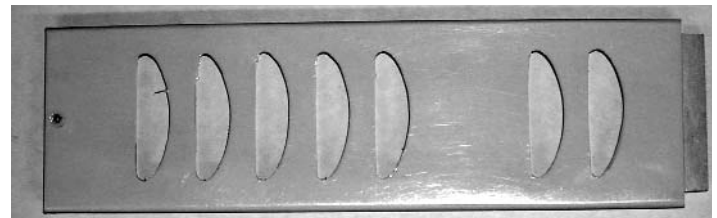

4.  Remove the hatch from the fuselage and carefully cut out each of the air holes

**Note: Reinforce the hatch with small sticks if using 7 cell batteries**

**NOTE: The air holes let the battery cool for better performance.**



5.  Slide the canopy under the cowl. The rear of the canopy will sit on top of the wing with the rubber bands holding the wing will also hold the canopy.

## BALANCING ( Center of Gravity)

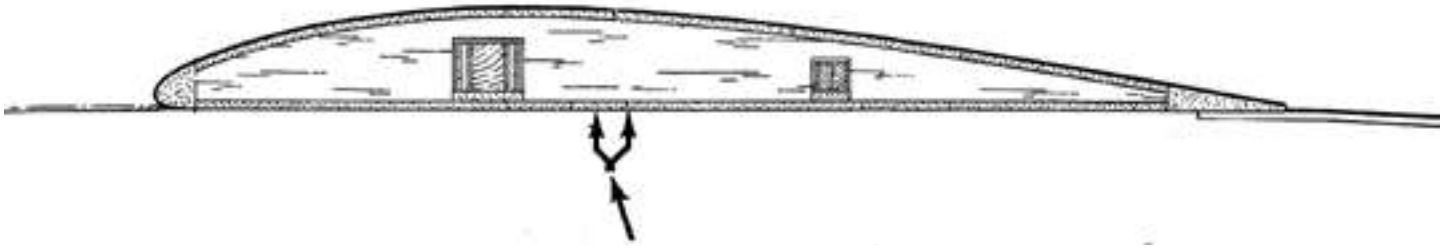

While the wing is rubber banded in place on the fuselage measure back from the leading edge of the wing 3-1/2" to 3-3/4" to find the center of gravity.

With everything installed, mount the wing and carefully check the Center of Gravity (CG). One way is to perch the model on the thumb and forefinger of your left hand (if you're right handed), while steadying the model with the other. A much better way is to use a balancing set-up, which can be made with a couple of 1/4" dowels with rounded tops, spaced just enough apart to clear the fuse. Mark the desired CG on the underside of the wing, and then set the model on the dowels at that location. Add weight if necessary for balance. The least weight is needed when added as far forward or back as possible.

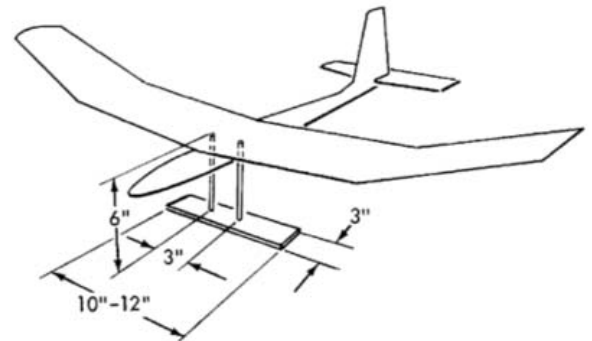

**DO NOT attempt to fly the model with the CG EVEN SLIGHTLY BEHIND the rearmost recommended position.**

## RADIO CHECK

**Before going to the field to fly**, with batteries fully charged, turn on receiver and transmitter and actuate all controls many times until you are satisfied with all functions.

**Prior to the beginning of each day's flying**, make a range check of your equipment in accordance with the manufacturer's instructions in general, with antenna

collapsed, you should have at least 100 feet range on the ground. To check this, set the model facing away from you, turn on both the transmitter and receiver switches, and walk away while transmitting signals. Watch to see that no signals are missed until you are at least 100 feet away. Do not attempt any flights unless the equipment works perfectly. **Be careful not to use your transmitter when someone else on the field is flying or testing on the same frequency.**

# MOTOR & BATTERY MAINTENANCE & CHARGING

**IMPORTANT! THIS SECTION CONTAINS MATERIAL ESSENTIAL TO YOUR SAFETY AND THE MAXIMUM PERFORMANCE OF YOUR ELECTRA!**

Please take the time to read this section very carefully. If you don't understand, read again or get help from an experienced electric pilot.

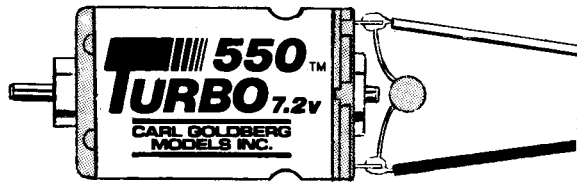

The Turbo 550 is a special motor designed for electric plane use on 6-cell 1200 MAH nicad battery packs. This battery is commonly used with 1/10 scale "off road" electric cars and is therefore readily available. 7-cell batteries also may be used and give a better climb rate, but this will produce a shorter engine run and the motor will run hotter. See figure A below.

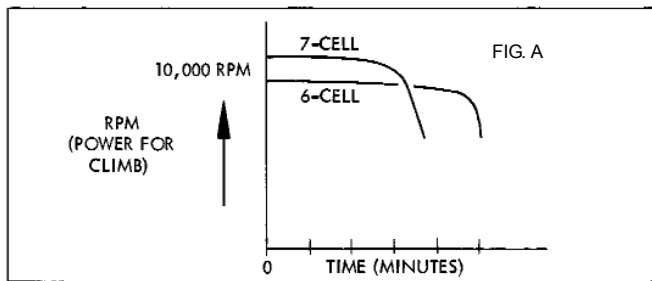

## MOTOR

The motor is ready-to-use; just install as shown and be sure there is enough ventilation around the motor for adequate cooling. After a few flights, you should notice a small increase in power, as the motor "breaks in." You may also wish to experiment with other propellers, but we recommend you stay in the 8-4 size range.

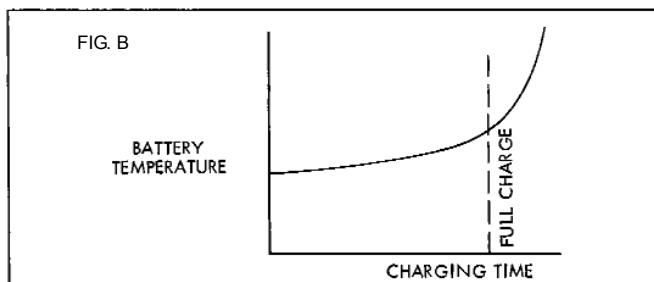

## BATTERY

**This section is particularly important!** One way to think of a battery charging is to imagine the battery as a bucket and electricity as water. What you are trying to do is to fill up the bucket (battery), but not overflow it.

At the very quick charge rate that is common with today's field charger's, there is little room for error. When you over-charge a battery, the temperature rises quickly and there is **potential for EXPLOSION**, or at least battery damage (Figure B). There are numerous ways to prevent this. **How** you charge depends on the **type** of charger you use.

**IMPORTANT! ALWAYS ALLOW THE BATTERY TO COOL BEFORE CHARGING.**

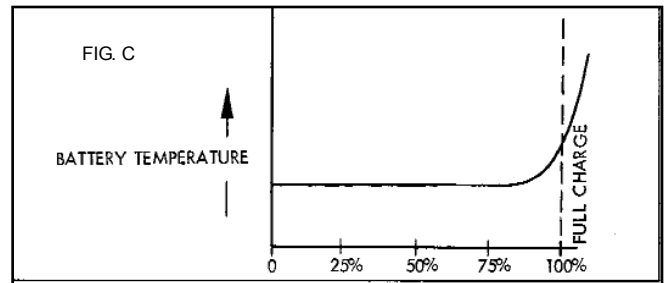

## TYPES OF CHARGER'S

**Basic Charger with a Timer.** To prevent an over-charge, you must know how full the battery is. A new or nearly empty battery should receive a full charge, per the instructions that come with the battery. This is usually about 15-minute charge (at 4.5 AMPS, if you have an ammeter.)

During the last 5 minutes, lightly and carefully touch the battery several times (ever minute or so). If it is slightly warm, that is OK. If it is hot to the touch, that signals that it is overcharged. **STOP CHARGING IMMEDIATELY!** Allow the battery to cool to room temperature (usually 15-20 minutes) before using.

If you don't know how full your battery is, set your timer for no more than 5 minutes and monitor the temperature by lightly touching the battery every 1-2 minutes. When the temperature starts to rise, the battery is fully charged. Stop immediately (Figure C).

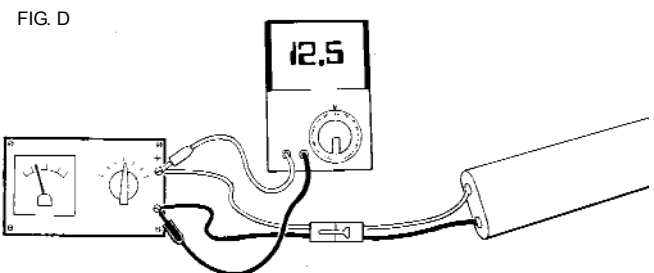

If you have a digital volt meter, it can be very useful in detecting when the battery reaches a full charge. As the battery fills, the voltage goes up. When it's fully charged, the voltage will stop rising and in a minute or two, as the battery temperature rises, the voltage will drop slightly. As soon as it drops, stop charging. This is an excellent way to get maximum batter performance. (Figure D.)

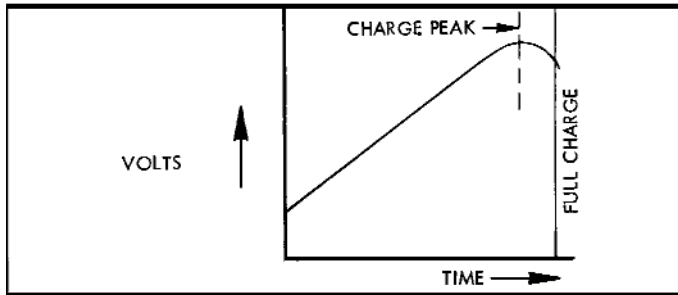

**Automatic Charger's.** DELTA or PEAK DETECTION CHARGER'S are excellent methods of charging a battery, as one simply connects the charger, pushes the start button, and waits. Within approximately 15-30 minutes, the battery may be disconnected and used. It is still a good idea to monitor the battery temperature (by lightly touching) every minute or so after 10 minutes of charging. If you suspect the battery is overcharging, STOP IMMEDIATELY!

TEMPERATURE SENSITIVE (THERMAL)CHARGER'S also work well, although they are more expensive the other charges described. The thermal charger charges a battery pack in approximately 15-20 and it doesn't matter how full the pack is charging begins. This charger "senses" when the battery temperature signals a full charge and automatically stops charging. However, the battery must be absolutely cool when charging begins, or the charger will cut off prematurely.

**Follow the manufacturer's instructions carefully when using any type of charger.**

### BATTERY EQUALIZATION

Any battery that hasn't been used for a week or more should be equalized for best performance. This is done by charging the battery for 10-20 minutes at the indicated rate and then giving the battery a trickle charge for three to four hours. Refer to the charger instructions for the recommended trickle charge technique. Equalizing the battery will assure top performance every time.

### HOW MANY BATTERIES ARE NEEDED?

To get in the most flying at each session, we suggest you purchase three battery packs. While one pack is cooling and waiting to be charged, a second pack can be on the charger, and the third pack can be in the plane and ready to fly. With only one battery pack, there may be up to a 40-minute wait between flights.

## "TREAT YOUR RADIO RIGHT AND IT WILL DO THE SAME FOR YOU!" by Hal deBolt

Today's RC systems are very well engineered and constructed. However, they will remain only as good as the way in which they are USED. Always follow the rules of proper usage and all manufacturer's instructions for your particular piece of equipment.

**TRANSMITTERS:** Keep your transmitter clean and free from fuel residue and dirt. Battery condition and RF output should be monitored, and the system should be aligned and tuned annually. Do not transport under vibration (such as on the floor of a car) without cushioning.

**RECEIVERS:** Receivers must be vibration free. When installing in the aircraft, wrap them in a minimum of ¼" soft foam rubber (not plastic foam). Keep well clear of all cables and batteries. Tune annually (or as recommended by the manufacturer), as indicated below under "Check-Ups."

**SERVOS:** Servos are vibration prone. Be sure to mount them with grommet shock mounts in servo trays which are also shock mounted. Also be sure to keep them clean. If the neutral position "drifts," this is a sign of change which should not be ignored; find out WHY before flying again.

**BATTERIES:** Nicads also can suffer from vibration, so they too should be wrapped in soft foam rubber before installing. Check their condition periodically by measuring the voltage with a volt meter or battery tester. Charge the batteries before EVERY flying session. When not used for a period of time (such as during the winter months) the batteries should be charged every 30 days. Never store batteries in a discharged condition.

**PUSHRODS:** Obviously, pushrods should be installed to operate freely, so that they place no load on the servo. Using a servo's power to move a tight rod or heavy surface by force increases the battery drain, shortens the electronic life, and can cause neutralizing problems. In addition, it is important the pushrods do not flex or vibrate. Any vibration is transferred directly to the servo, and its gear, motor, and pot. To avoid flexing and vibration, use guides and fairleads on the rods.

**CONNECTORS:** In using connectors, never pull on the wires to disconnect; grasp the plugs instead. Clean them by dunking in a solvent, such as dope thinner. Tape the connectors together when installing and make sure there is no strain on the cables.

**CHECK-UPS:** A full check-up by the factory or an authorized service center should be done AT LEAST ONCE A YEAR, as well as any time something unusual occurs during usage. A malfunction or "glitch" is the first sign of an impending failure; it should not be ignored. The checkup should include tuning and alignment of the system, as well as battery testing.

# FLYING THE ELECTRA

## LEARNING TO FLY

Flying R/C is both fun and challenging. As with other portions of this book, the following section is meant to introduce you to the basics. Read carefully before taking your model out to the field and attempting first flights. And remember, becoming an R/C pilot takes time and patience, but the rewards are well worth the effort.

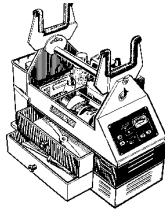

CGM SUPERTOTE

### Equipment Checklist

- Flight batteries, fully charged
- Extra battery packs
- Radio transmitter
- Battery charger
- Tools for tightening any parts that can vibrate and loosen
- Extra #64 rubber bands
- Extra props and an extra spinner
- Prop wrench
- Bottle of **Super Jet™**

## CHECK YOUR EQUIPMENT

Prior to going to the flying field, with radio batteries fully charged, turn on both receiver (Rx) and transmitter (Tx) and actuate all controls many times until you are satisfied with all functions.

Before beginning each day's flying, make a range check of your equipment in accordance with the manufacturer's instructions. In general, with transmitter antenna collapsed to 6"-8", you should have an at least 100 foot range on the ground. To check this, turn on both the transmitter and the receiver switches, set the model heading away from you, and walk away while transmitting signals to move the control surfaces. Watch to see that no signals are missed until you are at least 100 feet away. Only if the equipment works perfectly should any flights be attempted. Again, **be careful to not use your transmitter when anyone else at the field is flying or testing on the same frequency!**

After the range check, stand behind the model and make sure the control responses are correct. Moving the control stick to the right should give right rudder (on a 3-channel set-up). Moving the stick back or down on the Tx should move the elevator up, and vice versa.

Finally, make sure that everything on your aircraft is neatly and firmly in place-motor fastened down, servos

snugged down, receiver and battery wrapped in foam rubber, etc. Prop and spinner must be tight. The receiver antenna must be extended, not coiled up inside the model. Nothing should be loose, or unfinished, or unchecked.

With everything ready, the motor should be started for a short time. While the motor is running, make sure the control surfaces do not jitter or move until you command them and that the motor switch also responds properly to your command.

With transmitter and receiver switched on, hand launch the model directly into the wind. Gently correct the flight path as necessary. If any adjustments are needed to maintain straight and level flight, get experienced help to move the clevises.

In flight control, most of the beginner's trouble comes from over-controlling or holding a signal too long. It is better to operate your transmitter slowly and smoothly.

A troublesome tendency is letting the model get downwind. New flyers should try to keep the model upwind at all times prior to the landing approach.

If you are a novice, seek the help of an experienced flyer. Do not hesitate to ask one of the better flyers at the field for help. Usually, they are glad to spend a little time to get somebody started right, and they very likely were helped in the same manner themselves.

## WHERE TO FLY

Fly only in areas sanctioned for R/C and known to be free of radio interference. Ask your hobby dealer or other modelers if there is an R/C flying field that is used by a local R/C club. This is the ideal place to fly. If you don't know of an R/C club nearby, contact the Academy of Model Aeronautics (AMA), at the address on the front of this booklet, for information on a club in your area. Remember: R/C flying fields need to have rules to help prevent accidents, so ask about them before you turn on any of your equipment! **DO NOT TEST your transmitter in the parking lot or anywhere nearby until you are sure no one else is using your radio frequency. This could cause another flyer to crash and make you very unpopular!**

If there is no club or other R/C flying site available, locate a square area (preferably a grassy field), at least **four or five football fields long**, which is free of power lines, trees, poles, houses, busy streets and other obstructions. It must be at least three miles away from any areas where other R/C models, such as boats or cars, are operated. It should also have a relatively smooth surface, as it will take practice to learn precision landings. If you find a suitable location, turn your receiver on for 2 or 3 minutes to check that no one in the vicinity is operating an R/C device which could affect your receiver and cause your plane to crash.

The Electra was designed for long, slow, relaxed flying - not loops or similar aerobatic maneuvers. Save that kind of flying for your next, higher performance sport plane. Practicing precise control and glide planning on the Electra is good preparation for the demands of advanced aerobatic flying.

We recommend you use 3 channels, as this will allow you to cut power whenever you wish to do so. On your first few flights, after a couple of minutes, you may feel you have "had enough" and want to land and relax. A 2-channel system without motor control will not give you this option; you will have to keep flying until the battery power runs down.

You can expect a good solid 4 or 5 minutes of powered flight with a properly charged battery. In this amount of time, Electra will gain several hundred feet of altitude and will allow you time to get oriented and familiar with the control "feel." When the battery power begins to run out, climb will slow down and the model will begin a slow descent. You should continue flying your same flying pattern as the model slowly glides.

For your initial landings, you should not be concerned about trying to land at a specific spot. Your prime concern should be a controlled landing, always into the wind,

with wing level. With practice, you will be able to plan your approaches to land just about where you want.

## HAND LAUNCHING

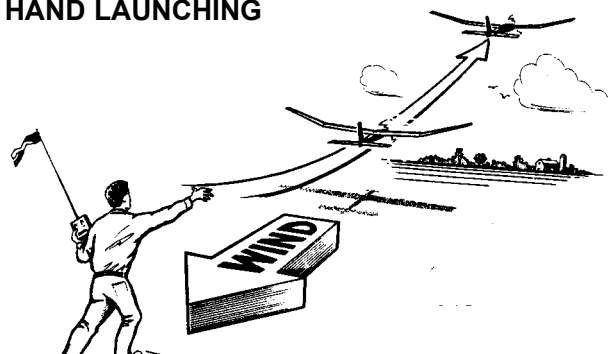

The Electra must be hand launched. This is easy to do, but must be done carefully to avoid damaging the model. It is best to launch over some tall grass. Facing INTO the wind, hold the transmitter in one hand, the model in the other and raise it above your head. The wings should be level and the nose pointing straight ahead-not slightly up. Imagine that you are gliding it towards a spot about 50 feet ahead. DO NOT throw the model UP. It's a natural tendency, but it will make the model stall (fall) and dive to the ground.

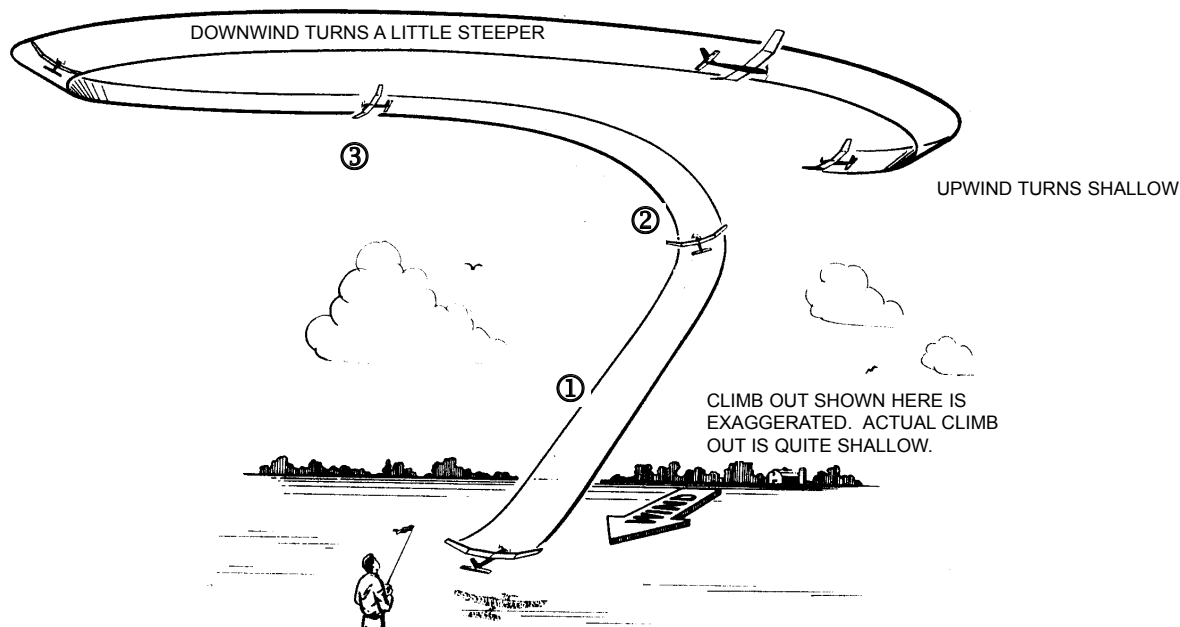

After checking all controls, seeing that the Tx trim tabs are centered, and making sure the Tx meter registers in the safe zone, turn on the motor and hand launch the model into the wind. Immediately take the Tx in both hands and, remembering to operate the controls smoothly, begin to direct the model in a gentle climb. Add slight back stick pressure, if necessary, to keep the model from descending. Soon, when it is about 100 feet away from you, it will start to climb. Be patient; let it climb slowly. If the climb is too steep, the model will stall and fall to the ground. Avoid over-controlling.

**CLIMB OUT.** 1. During the climb out, just try to keep the model flying into the wind with the wings level until you

reach an altitude of at least 150 feet.

**STARTING THE PATTERN** 2. At 150-200 feet of altitude, add just a touch of left or right stick pressure until the model begins a very shallow turn in the direction you want to go. 3. Try to maintain this shallow turn. The wind will tend to blow your plane and the pattern further downwind. Try to keep it flying upwind at all times prior to your landing approach. It is more difficult to fly a model when it is downwind, and if a mistake is made, the model will end up further downwind, making it more difficult to fly back to the field. To compensate for wind, continue to make upwind turns shallow, but make the downwind turns a little steeper.

to fly a model when it is downwind, and if a mistake is made, the model will end up further downwind, making it more difficult to fly back to the field. To compensate for wind, continue to make upwind turns shallow, but make the downwind turns a little steeper.

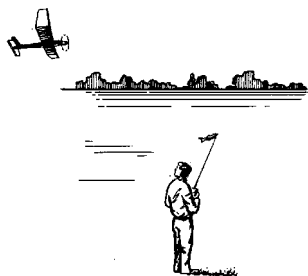

When the plane comes toward you, the steering will seem reversed. When you give right rudder, the plane turns to your left, but it is actually turning to *its* right. With practice, you will soon get used to this. (It's a good idea to practice using the controls with the model sitting on a table before you actually begin flying.) Simply push the stick left or right towards whichever way the ship is turning. A helpful technique is shown in the above sketch. You may feel less disoriented and better able to control the model by facing in the same direction as the plane is flying and looking over your shoulder.

As you get used to the controls, you probably will notice the model turning somewhat to the left or right, or climbing or descending, without any stick pressure on your part. These tendencies can be corrected in the air by moving the trim tabs on the Tx. After landing, get an experienced flier to help adjust the setting of the rudder or elevator by adjusting the mini-snaps (clevises). If the wing or other structures have become warped, it is best to discontinue flying and take the model home to straighten it.

If flying with a 2-channel system, when the battery begins to run out, the model will start a gradual descent. If flying a 3-channel system, it's good to have a helper to let you know when you have been flying for about four minutes. Then you can turn the motor off and have about one or two minutes of battery power left. If you are not happy with your first approach, you will then be able to restart the motor and set up another pass.

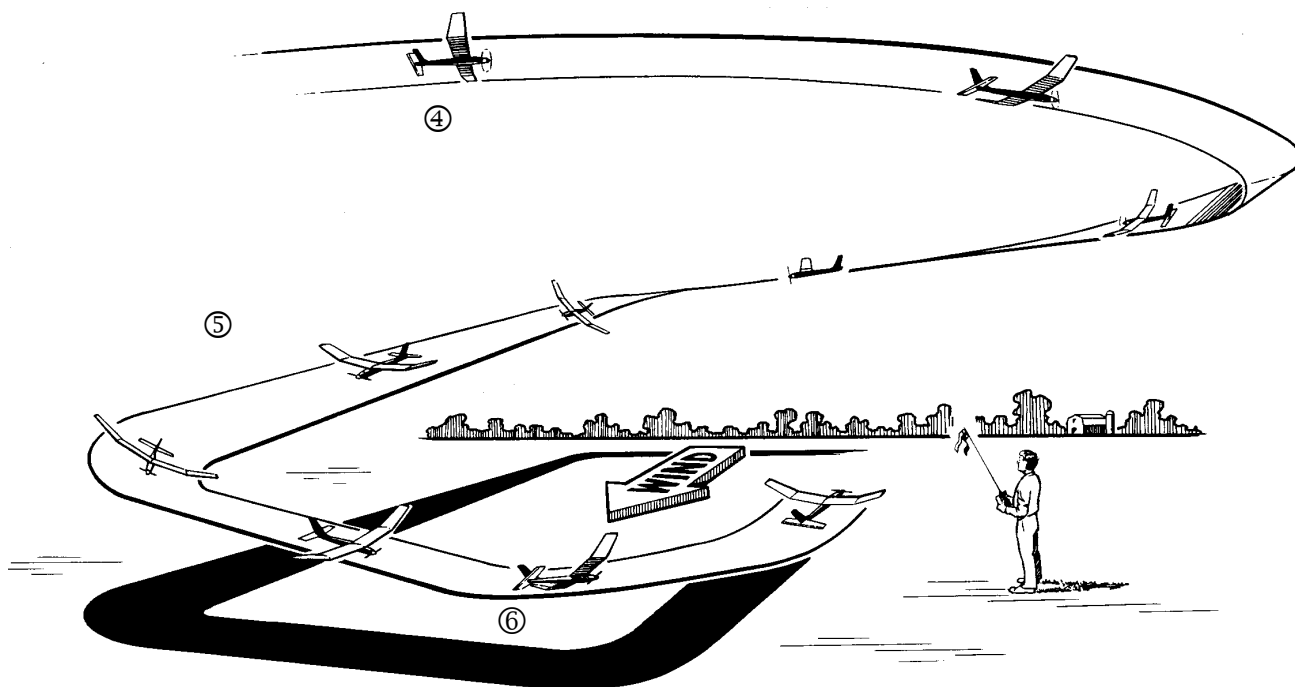

## LANDING

4. Continue your pattern and try to determine how much longer the model will glide. Start planning for the landing. With the power off, you will get used to the model's glide. 5. Try to plan your approach so that the model is about 100 feet high and ready to complete the downwind portion of your pattern. 6. Continue making a shallow turn, bringing the plane around until you have it pointed directly into the wind. Be patient and keep your glide steady and gentle, with the wings level. 7. A controlled landing into the wind is your prime concern. Don't worry about trying to land the model near you when you are

first learning to fly. It is better to walk a few blocks to recover a whole airplane than to pick up pieces at your feet! Just before the model is ready to touch down, you can add just a touch of back stick pressure to "flare" the landing. Retrieve your plane and switch off first the transmitter and then the receiver.

Take things slow and easy and you'll be able to enjoy flying your Electra for years to come.