



Perfect Appearance Excellent Performance

精 于 静 精 于 动

Extra 300

OPERATING MANUAL



Please visit both our Facebook fanpage and our homopage for updated product information

WARNING!

 **WARNING:** Read the ENTIRE instruction manual to become familiar with the features of the product before operating. Failure to operate the product correctly can result in damage to the product, personal property and cause serious injury.

This is a sophisticated hobby product and NOT a toy. It must be operated with caution and common sense and requires some basic mechanical ability. Failure to operate this Product in a safe and responsible manner could result in injury or damage to the product or other property. This product is not intended for use by children without direct adult supervision.

This manual contains instructions for safety, operation and maintenance. It is essential to read and follow all the instructions and warnings in this manual prior to assembly, setup, or use, in order to operate correctly and avoid damage or serious injury.

Safety Precautions and Warnings

As the user of this product, you are solely responsible for operating in a manner that does not endanger yourself and others or result in damage to the product or the property of others. This model is controlled by a radio signal subject to interference from many sources outside your control. This interference can cause momentary loss of control so it is advisable to always keep a safe distance in all directions around your model, as this margin will help avoid collisions or injury.

Age Recommendation: Not for children under 14 years. This is not a toy.

- Never operate your model with low transmitter batteries.
- Always operate your model in an open area away from cars, traffic or people.
- Avoid operating your model in the street where injury or damage can occur.
- Never operate the model in the street or in populated areas for any reason.
- Carefully follow the directions and warnings for this and any optional support equipment (chargers, rechargeable battery packs, etc.) you use.
- Keep all chemicals, small parts and anything electrical out of the reach of children.
- Moisture causes damage to electronics. Avoid water exposure to all equipment not specifically designed and protected for this purpose.
- Never lick or place any portion of your model in your mouth as it could cause serious injury or even death.



Table of contents

<i>Kit contents</i>	1
<i>The spare parts list</i>	1
Spare parts list content	
The illustration of the spare parts	
<i>Kit Inspection</i>	3
<i>Charging the Flight Battery</i>	3
<i>Low Voltage Cutoff</i>	4
<i>Assemble the plane</i>	4
Install the main landing gear	
Mount the rudder	
Install the control horn	
Install the horizontal stabilizer	
Install the wing fillet	
Mount the main wing	
Install the receiver	
Install the battery	
Install the servo arm and the linkage rod	
<i>Get your model ready to fly</i>	11
Important ESC and plane information	
The transmitter and model setup	
Check the control throws	
Check the motor rotating direction	
Install the propeller set	
Glue the air exhaust pipe into place	
Check the C.G. (Center of Gravity)	
<i>Before the model flying</i>	17
Find a suitable flying site	
Perform the range check of your plane	
Monitor your flight time	
<i>Flying course</i>	18
Take off	
Flying	
Landing	
Maintenance	
<i>Troubleshooting</i>	19
<i>AMA</i>	20

Kit contents

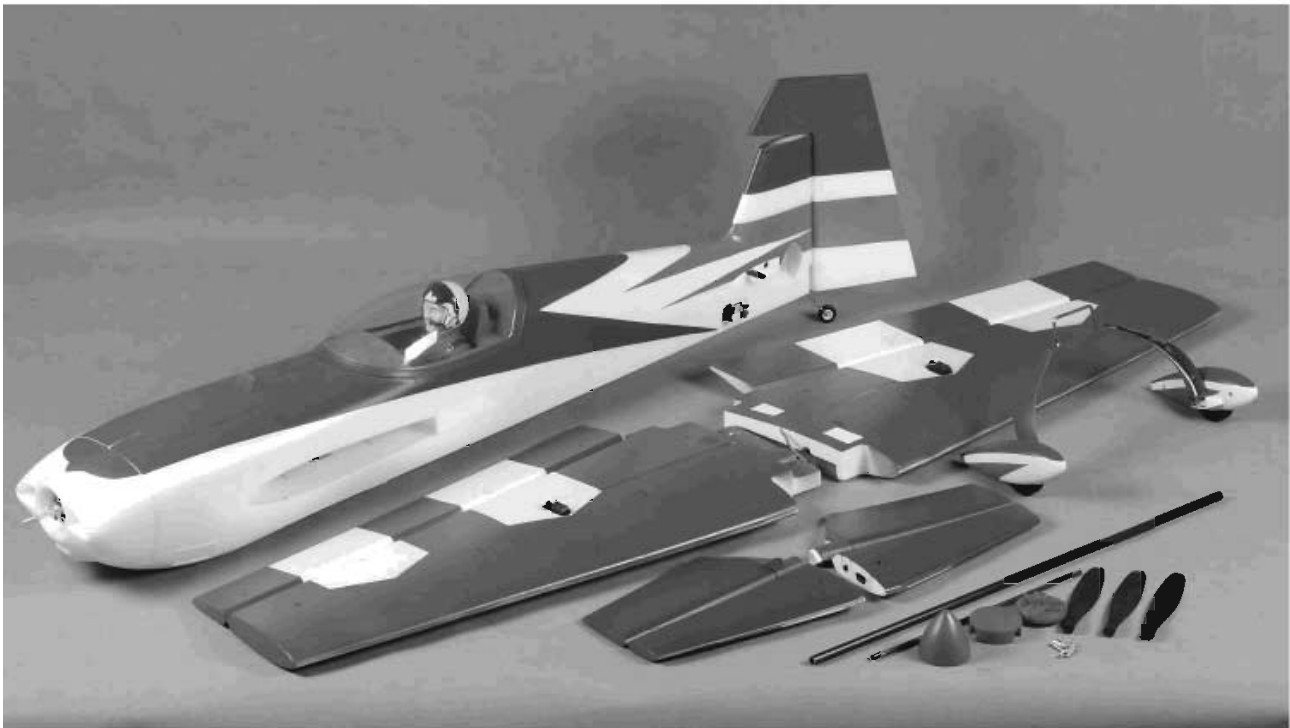

Kit contents

1. The fuselage assembly (With the motor, the canopy, the electronic parts, ESC)
2. Rudder (With hinges installed)
3. Horizontal stabilizer
4. Landing gear set
5. Propeller and spinner
6. Spare parts bag
7. Main wing tube and the tail wing tube

The spare parts list

Replacement parts for the **FMS Extra 300** are available using the order numbers in the Spare parts list that follows. The fastest, most economical service can be provided by your hobby dealer or mail-order company.

Spare parts list content

Spare parts list content

- SZ 101 Fuselage (With all the plastic parts and rudder installed)
- SZ 102 Main wing set (With the control horn in stored)
- SZ 103 Horizontal stabilizer (With the elevator connector installed)
- SZ 104 Cowl
- SZ 105 Canopy (The plastic canopy)
- SZ 106 Pilot
- SZ 107 Main landing gear set (With the strut and the wheel pants)
- SZ 108 Rear landing gear set

SZ 109 Spinner

SZ 110 Propeller blade (There pieces 13*5 blades)

SZ 111 "X" motor mount

SZ 112 Motor (3948 KV760)

SZ 113 Switch mode ESC (60Amp with 3A BEC)

SZ114 17g Servo (With the servo arm and the arm mounting screw)

SZ 115 Battery (4 cells Li-Po battery 2600mAh 25C)

SZ 116 Hinge (5 Pieces nylon hinges)

SZ 117 Motor board

SZ 118 Linkage rod (With the clevis and the securing rings)

SZ 119 Motor shaft

SZ 120 Decal sheet

Note: All of the parts are painted with no decal applied.

The illustration of the spare parts



SZ-101



SZ-102

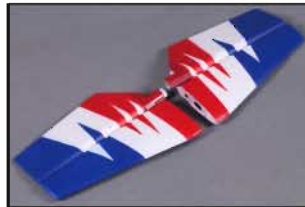

SZ-103



SZ-104



SZ-105



SZ-106



SZ-107



SZ-108



SZ-109



SZ-110



SZ-111



SZ-112



SZ-113



SZ-114



SZ-115

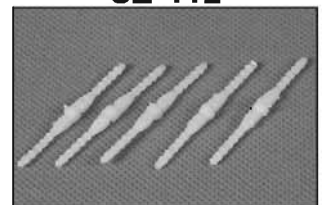

SZ-116



SZ-117



SZ-118



SZ-119



SZ-120

Kit inspection

Before starting to build, inspect the parts to make sure they are acceptable quality. If any parts are missing or are not in good shape or acceptable quality, or if you need assistance with setup and assembly, please feel free to contact FMSteam. Please write down the name of the parts when you are reporting defective or missing of them.

FMSteam Product Support

ADDRESS: 3/F, Building B, 3rd Industry Zone, Matigang, Dalingshan Town, Dongguan City, P.R.C

Ph: 0086-769-86976655

Charging the Flight Battery

The Battery Charger is designed to safely charge the Li-Po battery,

Caution: All instructions and warnings must be followed exactly. Mishandling of Li-Po batteries can result in fire, personal injury, or property damage.

Battery warning:

By handling, charging or using the included Li-Po battery you assume all risks associated with lithium batteries.

If at any time the batteries begin to swell, or balloon, discontinue use immediately! Charging or discharging a swelling or ballooning battery can result in fire.

Always store the batteries at room temperature in a dry area to extend the life of the battery. Always transport or temporarily store the battery in a temperature range of 40-120°F. Do not store battery or model in a car or in direct sunlight. If stored in a hot car, the battery can be damaged or even catch fire.

Never use a Ni-Mh charger. Failure to charge the battery with a compatible charger may cause fire resulting in personal injury and property damage.

Never discharge Li-Po cells to below 3V.

Never leave charging batteries unattended.

Never charge damaged batteries.

Charging the flight battery

When charging the battery, make certain the battery is on a heat-resistant surface, charge the battery before assembly of the airplane. Install the fully charged battery to perform control tests and binding.

Low voltage cut off (LVC)

When a Li-Po is discharged below 3V per cell, it will not hold a charge. The ESC protects the flight battery from over-discharge using Low Voltage Cutoff. Before the battery charge decreases too much, LVC removes power from motor in two ways: (1) Reduces power - ESC reduces motor power (recommended), (2) Hard cutoff - ESC instantly cuts motor power when the pre-set Low Voltage Protection Threshold value is reached. These settings can be changed using the ESC programming guide.

Assemble the plane

Install the main landing gear

1. Install the main landing gear by fitting the gear into the fuselage fully as the picture shows.

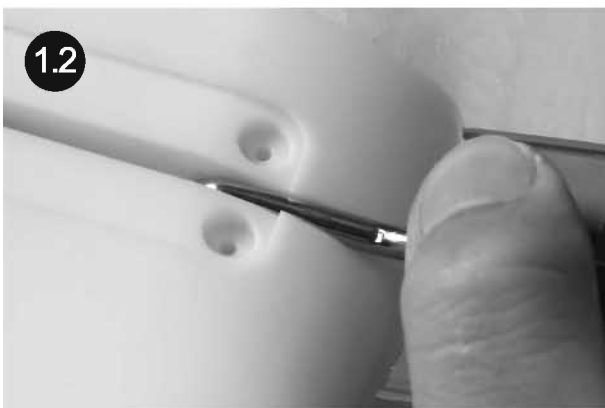
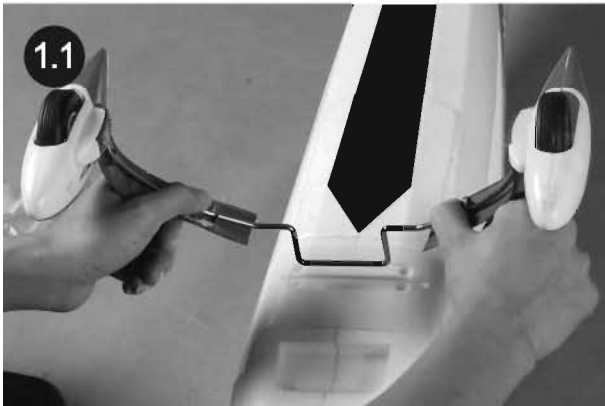

2. Install the fairing plate to the pre-notched slot on the landing gear fairing base.

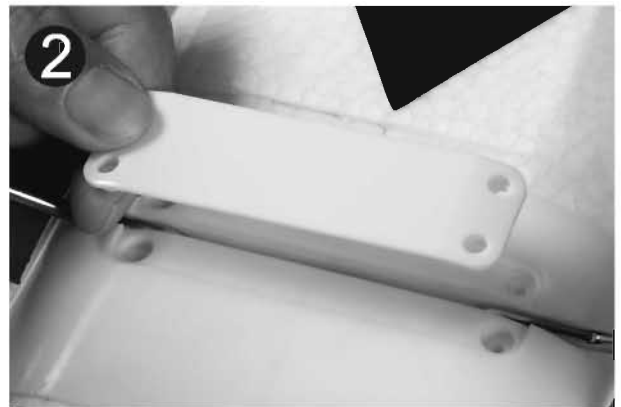

3. Secure the fairing plate using 4 pieces of screws in stored with the plate.



Assemble the plane

Hinge on the rudder

1. Apply glue to the holes on the vertical stabilizer for the rudder hinges installation.

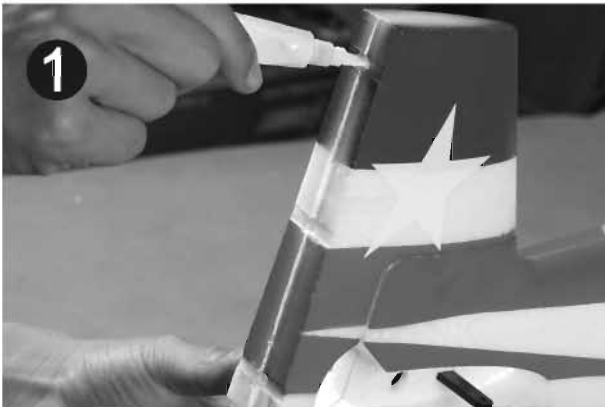

2. Insert the rudder hinges to the tail fin,
Note: Insert the L bend of the rear landing into the rudder control horn base while mounting the rudder.

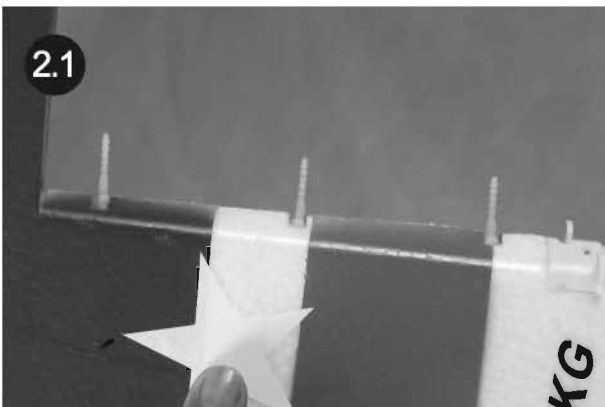

3. Do not insert the eyelets of the hinge into the vertical fin, or it will impede the free movement of the rudder, after the mounting of the rudder, check to make sure the counterbalance leading edge **A** will align with the edge **B**, the leading edge **C** will parallel to the trailing edge **D**. Adjust any misalignment before the glue dries thoroughly.

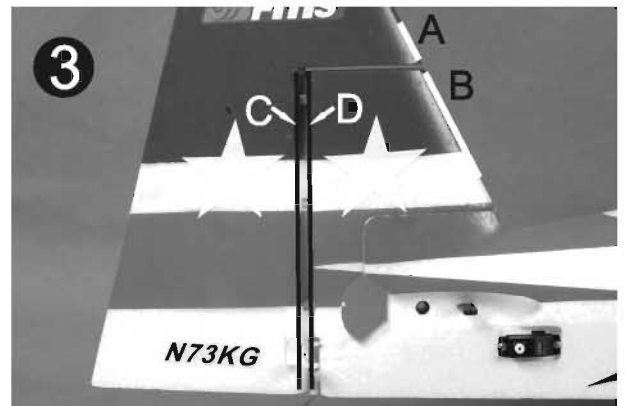

4. Secure the rear landing gear strut using the pre installed screws.



Assemble the plane

Install the control horn

1. Attached the control horn to the aileron downside with it toward the hinge line and secure it using the provided screws from the horn side.

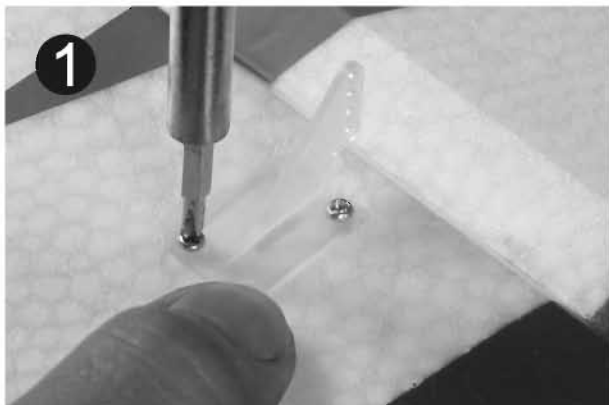

2. Check to make sure the screws are firmly grabbed into the back plate of the horns.



Install the horizontal stabilizer

1. Insert the port side(Left) stabilizer half into the tail mounting slot with the Red and Blue painting side face up.



2. Slide the horizontal connecting tube into the round hole located in the stabilizer mounting slot.



3. Slide the starboard(Right) stabilizer onto the tube, make sure the stabilizer tube, the stabilizer connector and the elevator joiners are interlock to the relative parts at the same time.

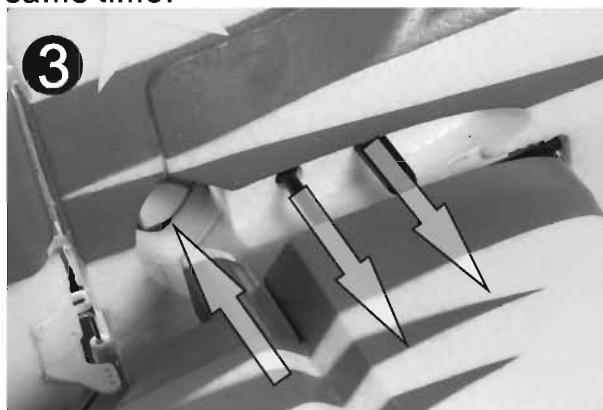

4. Fully seat the stabilizer into place and secure the rudder using the provided screws. **PWA 3.0*15(2PCS)**

Note: Do not over tighten the screws but make sure it is tight enough.



Assemble the plane

Install the main wing fillet

1. Take the wing fillet out and do not rashly glued them into place due to their almost the same outline, the fillet for the starboard (R) and the port side (L) have been factory marked respectively for the handy usage.



2. Apply the glue to the fuselage where it mating with the filler together thoroughly using a blue brush or any other applicator.

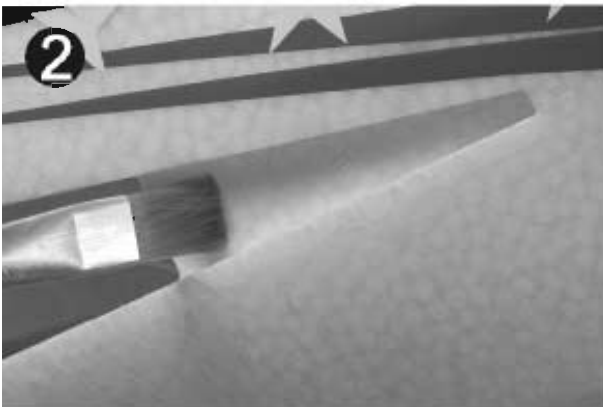

3. Make the model fuselage stands rightly on model stand, check to make sure the wider side of the fillet face down, please refers to the picture for the proper installation of the fillet.

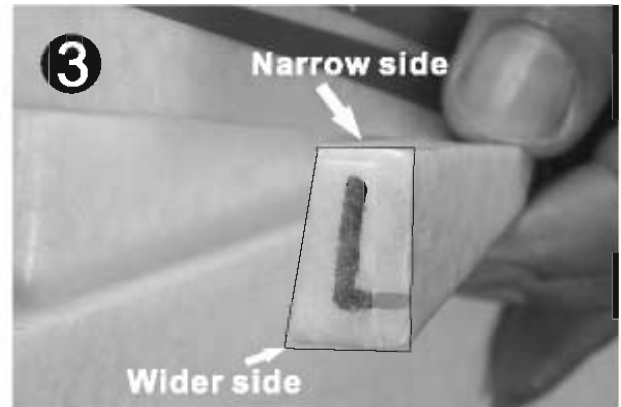

Assemble the plane

Mount the main wing

1. Turn over the fuselage so the bottom of the plane face up, slide the starboard wing panel into the wing mounting saddle while threading the aileron control servo lead to the fuselage.

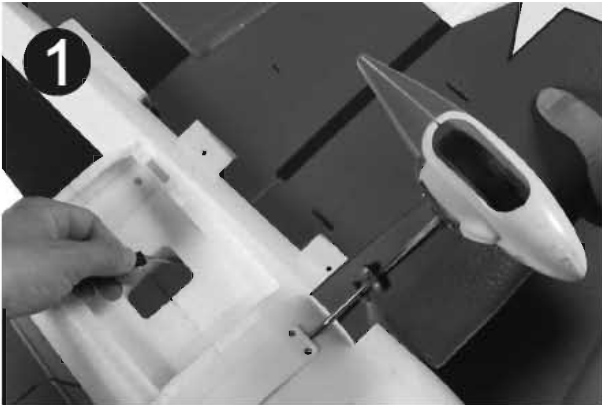

2. Insert the main wing panel reinforcing connecting tube into the round hole in the wing saddle and straight to the socket in the main wing.

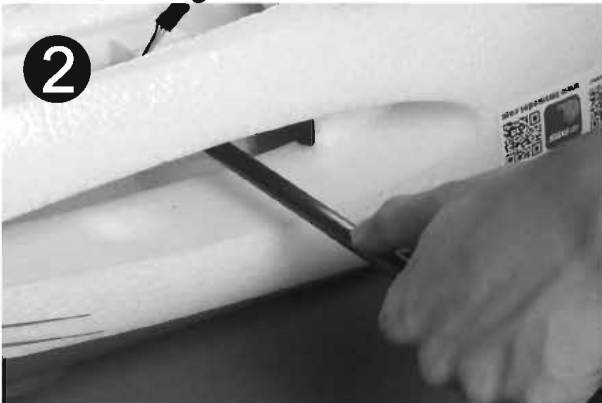

3. Slide the port side(Left) wing to the wing tube all the way to the wing saddle the same with the right panel, make sure the wing panels will contact to each other when viewing from the bottom of the servo hatch.

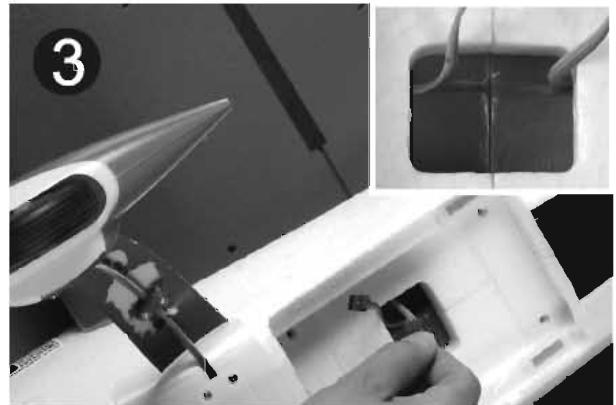

4. Secure the main wing form the servo hatch using four pieces of provided machine screws. (Screw: PM 3.0*60)

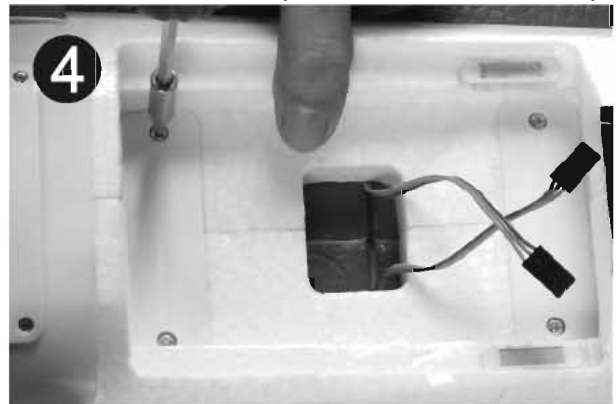

Install the receiver

1. Attach the aileron control horn to the Y-Harness in the fuselage.

Note: There is no difference between the two plugs on the Y-Harnes.

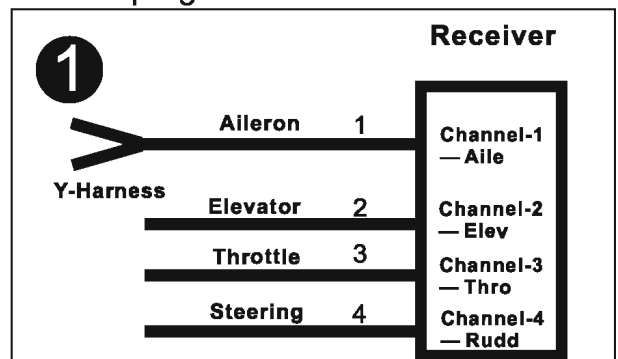

2. Attach aileron servo to the Aileron channel of your receiver. Elevator plug goes to elevator channel of your receiver. Rudder servo goes to the Rudder channel. Attach the ESC connector to the throttle channel of the receiver.

Assemble the plane

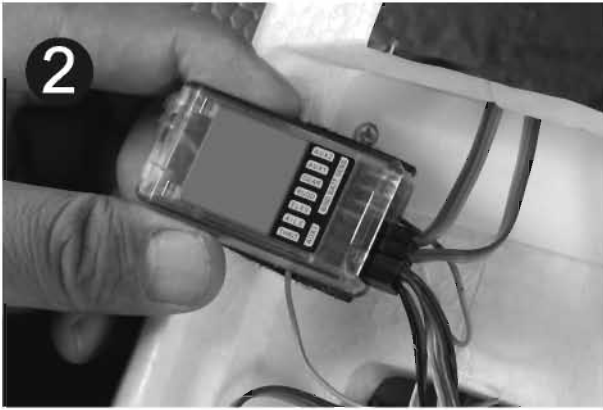

3. Attach the receiver to the receiver hatch using the velcro tape.



Install the battery

1. Slide the battery into the battery hatch with the power supply cable toward the rear end of the plane and secure it using the pre installed hook and loop tape.
Note: You may need to relocate the battery position to achieve the correct CG for your **Extra 300** model.

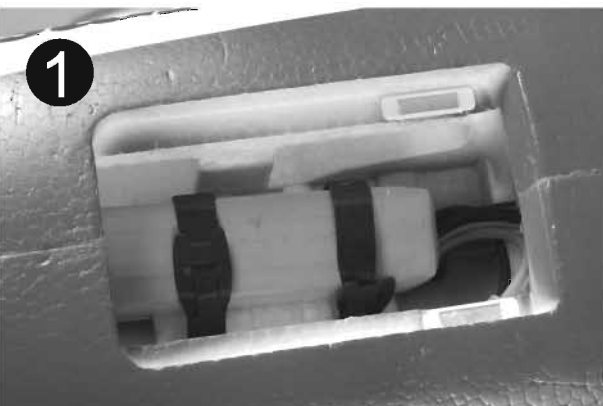

Install the servo arm and the linkage rod

1. Install the aileron servo arms, make sure it is standing perpendicular with the servo box.

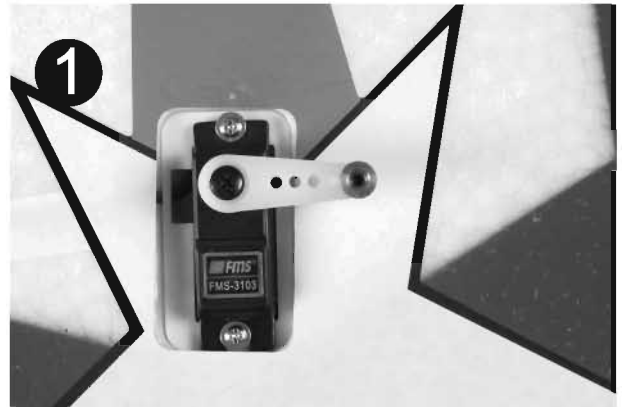

2. Make sure the connection between the servo arm and the control horn nose is almost perpendicular with the hinge line.

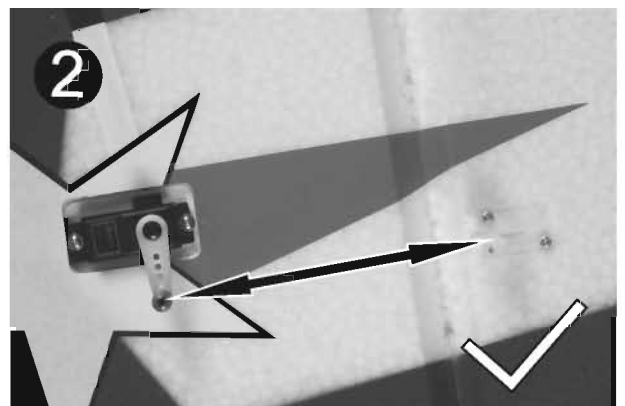

3. Verify the wrong way to mount the ailerons servo arm.

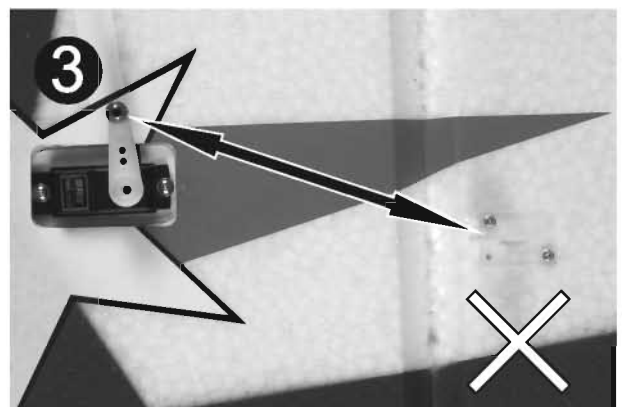

Assemble the plane

4. The bags contain the linkages for the aileron, elevator and the rudder have been marked respectively.



5. Insert the bare end of the linkage rod into the control connector.



6. Snap the clevis into the surface control horn.



7. The provided piece of fuel tubing keeps the clevis closed during flight. Secure all the linkages the same way.

Note: Do not over slide the securing tube or it will impede the movement of the surface control horn. Install all of the linkages the same way.

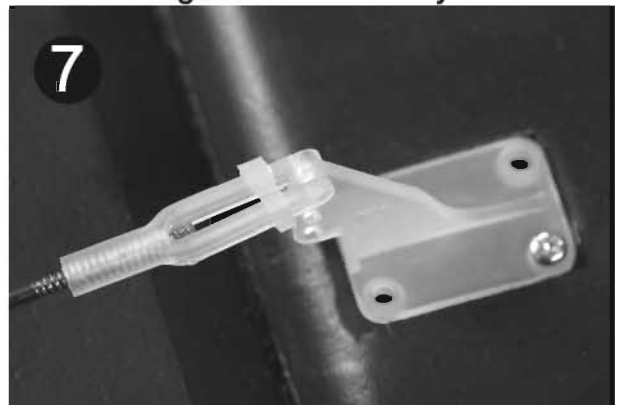

8. Install the elevator control servo arm on port side of the plane, make sure the arm will toward the upside of the plane.



9. Install the rudder control servo arm on starboard of the plane, make sure the arm will toward the downside of the plane.



Important ESC and model information

1. The ESC included with the **Extra 300** has a safe start. If the motor battery is connected to the ESC and the throttle stick is not in the low throttle or off position, the motor will not start until the throttle stick is moved to the low throttle or off position. Once the throttle stick is moved to the low throttle or off position, the motor will emit a series of beeps. Several beeps with the same tune means the ESC has detected the cells of the battery. The count of the beeps equals the cells of the battery. The motor is now armed and will start when the throttle is moved.
2. The motor and ESC come pre-connected and the motor rotation should be correct. If for any reason the motor is rotating in the wrong direction, simply reverse two of the three motor wires to change the direction of rotation.
3. The motor has an optional brake setting. The ESC comes with the brake switched off and we recommend that the **Extra 300** be flown with the brake off. However, the brake could be accidentally switched on if the motor battery is connected to the ESC while the throttle stick is set at full throttle. To switch the brake off, move the throttle stick to full throttle and plug in the motor battery. The motor will beep one time. Move the throttle stick to low throttle or the off position. The motor is ready to run and the brake will be switched off.
4. **Battery Selection and Installation.** We recommend the 14.8V 2600mAh 25C Li-Po battery. If using another battery, the battery must be at least a 14.8V 2600mAh 25C battery. Your battery should be approximately the same capacity, dimension and weight as the 14.8V 2600mAh 25C Li-Po battery to fit in the fuselage without changing the center of gravity significantly.
5. The specification of the model list as follows:
 - Wing span: 1300mm/51.2in
 - Length: 1285mm/50.6in
 - Motor : 3948-KV760
 - ESC : 60A with integrated 3A BEC
 - Battery : 14.8V 2600mAh 25C
 - Servo : 17g*4
 - Approx flying weight: 1880g
 - Propeller: 13*5 three blades scale propeller
 - Wing area: 37.1dm²
 - Wing loading: 50.7 g/dm²

Get your model ready to fly









The transmitter and model setup

Before getting started, bind your receiver with your transmitter. Please refer to your **Transmitter Manual** for proper operation.

CAUTION: To prevent personal injury, DO NOT install the propeller assembly onto the motor shaft while testing the control surfaces. DO NOT arm the ESC and do not turn on the transmitter until the **Transmitter Manual** instructs you to do so.

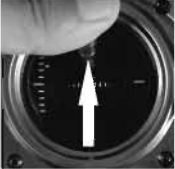
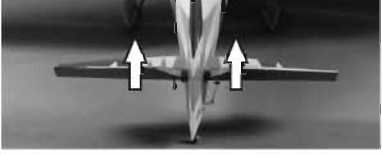
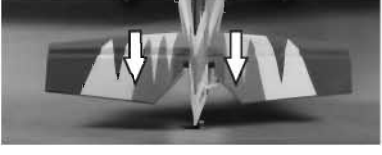
Tips: Make sure all control sticks on your radio are in the neutral position (rudder, elevator, ailerons) and the throttle in the OFF position. Make sure both ailerons move up and down (travel) the same amount. This model tracks well when the left and right ailerons travel the same amount in response to the control stick.

1. Move the controls on the transmitter to make sure aircraft control surface move correctly. See diagrams below. If controls respond in the opposite direction reverse the direction for operation of flight controls. Refer to your transmitter's instructions for changing direction of transmitter flight controls.

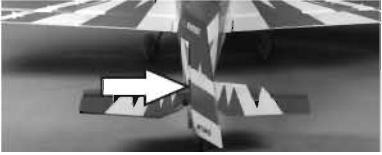
 <p>Bank Left</p>  <p>Bank Right</p>	 	Aileron
 <p>Climb</p>  <p>Descend</p>	 	Elevator
 <p>Yaw Left</p>  <p>Yaw Right</p>	 	Rudder/ Steering

Get your model ready to fly

2. Adjust the servo arms mechanically make sure all servo arms are fully vertical. If not, adjust the servo arm by using the trim function on your radio.
Note: For computerized transmitters, use the servo/channel sub-trim feature to make each servo arm fully vertical. Make sure the trims and the sub trims in neutral position before making some mechanically trim.
3. The standard hole settings for linkage connections are shown by the black arrows in the the diagram below. You can move the linkage to different hole positions to increase control surface travel and increase the aerobatics of the airplane.

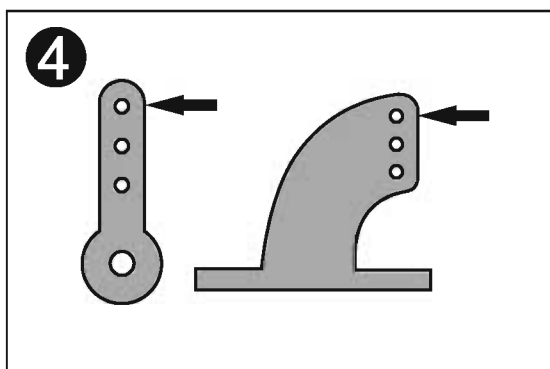

4. Align the control surfaces well by adjusting the linkage rod in the control connector. The ailerons align with the wing root fillet, the wing chord of the stabilizer and the elevator will arrange in a line and the counterbalance leading edge of the rudder with the vertical stabilizer leading edge.
Note: Use a drop of thread lock on the grub screws before securing the linkage rod.

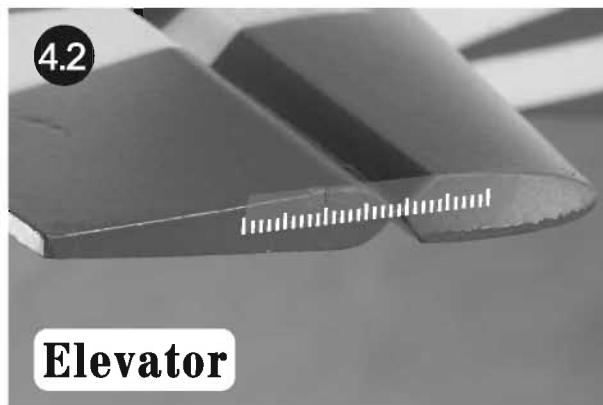
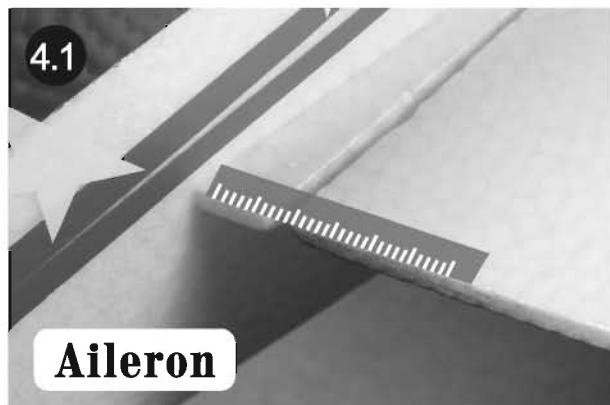

Get your model ready to fly

Check the control throws

1. Adjust ATV/travel adjustment on your transmitter until you obtain the following control surface travel. Do not adjust dual rates until you have correctly adjusted the total travel.

Ailerons: 60 to 70mm up and down (both ailerons), measured at the aileron root.

Elevator: 48 to 50mm up and down, measured at the counterbalance leading edge.

Rudder: 60 to 65mm left and right, measured at the stabilizer tip. The throw relative to the chord of the stabilizer.

2. The dual rates and the Exponential setting for intermediate flyers of FMS **Extra 300** are based on the ATV set in previous step.

	High Rate	Expo	Low Rate	Expo
Aileron	100% 65mm up/down	60%	30% 19mm up/down	30%
Elevator	100% 50mm up/down	50%	22% 11mm up/down	25%
Rudder	100% 60mm left/right	50%	60% 36mm left/right	25%

Note: 1. This control throws were developed by **FMS TEAM** for the best performance of the **Extra 300**. The small amount of elevator throw on low rate is capable of extreme aerobatics.

2. At first flight, fly the model in low rate. The first time you use high rates, be sure to fly at low to medium speeds. High rates, as listed, are only for **EXTREME** maneuvering. Only switch to high rate when the plane is flying at slow speed. Never fly at high speed at full air speed. This plane is very responsive and pilot can easily lose orientation. Get familiar with the plane first and then try high rate.

3. For take off and landing, low rate in all control surfaces is strongly recommended.

Check the motor rotating direction

1. The motor should rotate counterclockwise when viewing the plane from the front.



Glue the air exhaust pipe into place

1. Glue the exhaust pipe into the notch in front of the landing gear fairing base.



Install the propeller set

1. Put three propeller blades rightly onto the back plate. Make sure the letter with "FMS 13X5" on the propeller face up.

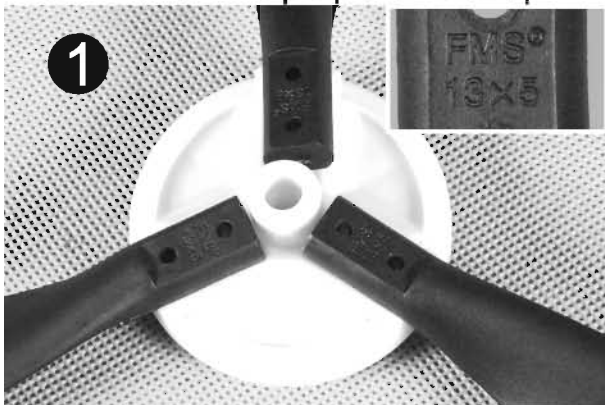

3. Secure it using the provided screws in spinner package (6pcs)



2. Cover the spinner middle part on the propeller. Make sure the propeller is fully inside the cover so the hole of cover and propeller can fully match. Place the nylon insert lock nuts rightly into the hex notch on bottom of the spinner back plate
 Note: 1. always hold the nuts into place in the process of the blades mounting.
 2. The round side of the nuts should be at outboard of the hex notch and facing up.

4. Verify the status of the propeller installation completed.



5. **CAUTION:** Disconnect the battery from the ESC before installing the propeller. Keyed the propeller assembly onto the hex nut of the motor shaft properly. Hand tighten the spinner and make sure it is tight enough.

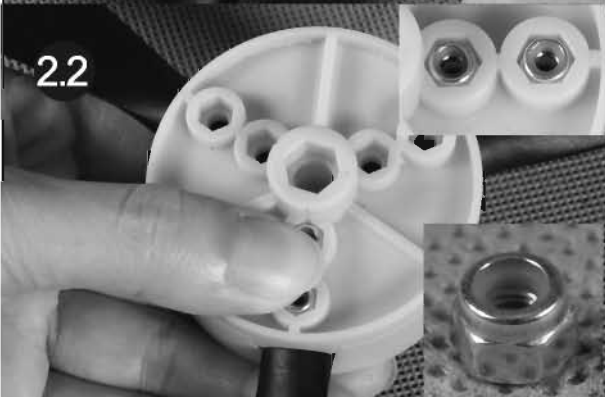

Get your model ready to fly

Check the C.G. (Center of Gravity)

Center of Gravity

When balancing your model, adjust the motor battery as necessary so the model is level or slightly nose down. This is the correct balance point for your model. After the first flights, the **CG** position can be adjusted for your personal preference.

1. The recommended Center of Gravity (**CG**) location for your model is **(120mm/4.8in)** forward from the leading edge of the main wing (as shown) with the battery pack installed. Mark the location of the **CG** on top of the wing.

2. When balancing your model, support the plane at the marks made on the bottom of the main wing with your fingers or a commercially available balancing stand. This is the correct balance point for your model. Make sure the model is assembled and ready for flight before balancing.

Caution: Do not connect the battery to the ESC while balancing the plane.

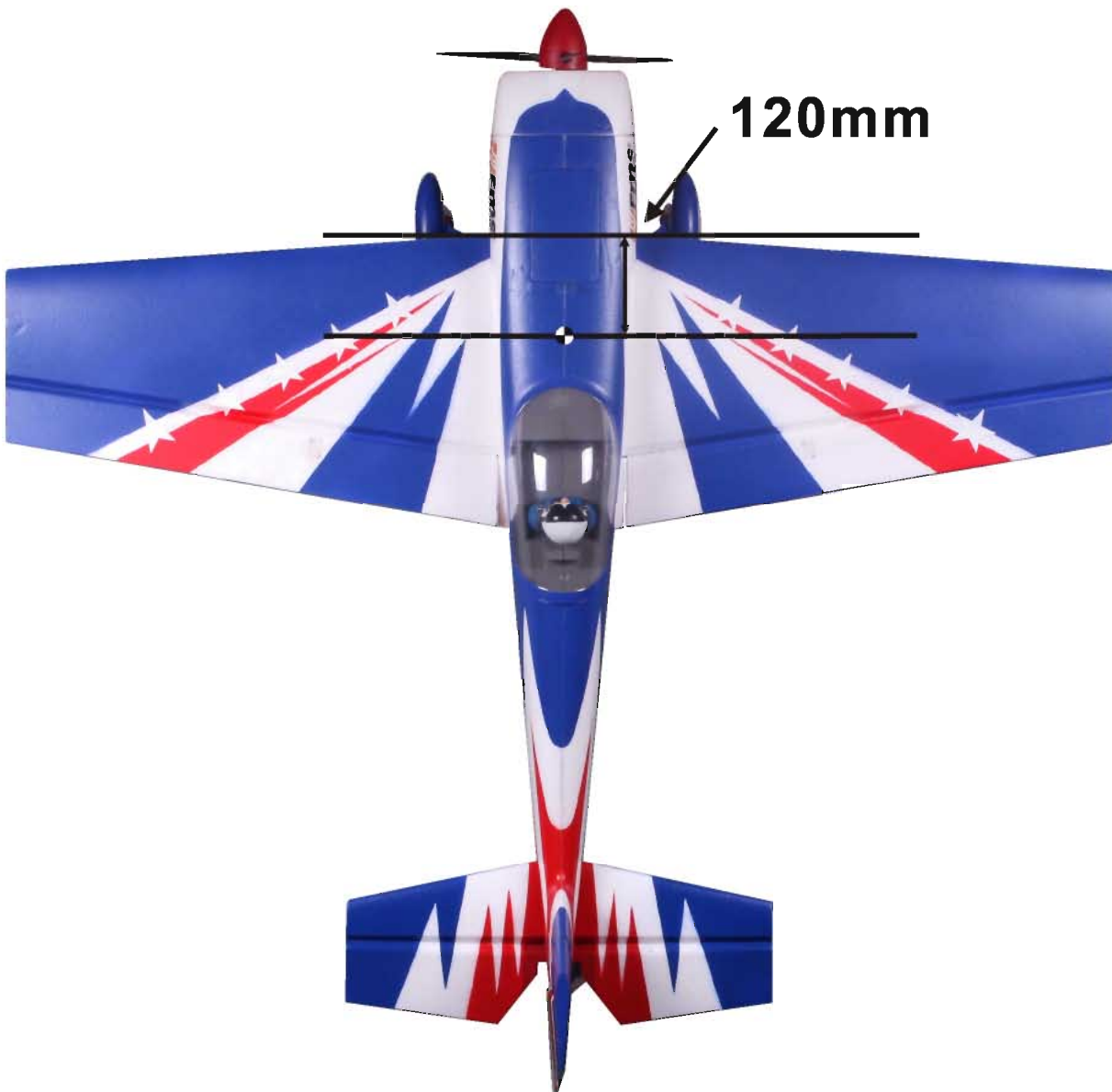

Before the model flying

Find a suitable flying site

Find a flying site clear of buildings, trees, power lines and other obstructions. Until you know how much area will be required and have mastered flying your plane in confined spaces, choose a site which is at least the size of two to three football fields – a flying field specifically for R/C planes is best. Never fly near people– especially children who can wander unpredictably.

Perform the range check of your plane

As a precaution, an operational ground range test should be performed before the first flight each time you go out. Performing a range test is a good way to detect problems that could cause loss of control such as low batteries, defective or damaged radio components, or radio interference. This usually requires an assistant and should be done at the actual flying site you will be using.

First turn on the transmitter, then install a fully-charged battery into the fuselage. Connect the battery and install the hatch.

Remember, use care not to bump the throttle stick, otherwise, the propeller / fan will turn and possibly cause damage or injury.

Note: Please refer to your **Transmitter Manual** that came with your radio control system to perform a ground range check. If the controls are not working correctly or if anything seems wrong, do not fly the model until you correct the problem. Make certain all the servo wires are securely connected to the receiver and the transmitter batteries have a good connection.

Monitor your flight time

Monitor and limit your flight time using a timer (such as one on a wrist watch or in your transmitter if available). When the batteries are getting low you will usually notice a performance drop before the ESC cuts off motor power, so when the plane starts flying slower you should land. Often (but not always) power can be briefly restored after the motor cuts off by holding the throttle stick all the way down for a few seconds.

To avoid an unexpected dead-stick landing on your first flight, set your timer to a conservative 4 minutes. When your alarm sounds you should land right away.

Flying course

Take off

While applying power slowly steer to keep the model straight, the model should accelerate quickly. As the model gains flight speed, you will want to climb at a steady and even rate. The **Extra 300** will climb out at a nice angle of attack (AOA).

Flying

Always choose a wide-open space for flying your plane. It is ideal for you to fly at a sanctioned flying field. If you are not flying at an approved site, always avoid flying near houses, trees, wires and buildings. You should also be careful to avoid flying in areas where there are many people, such as busy parks, schoolyards, or soccer fields. Consult laws and ordinances before choosing a location to fly your aircraft. After takeoff, gain some altitude. Climb to a safe altitude and begin to trim the model till it's tracks well through all aspects of flight, including high speed passes, inverted flight, loops, and point rolls.

Landing

Land the model when you hear the motor pulsing (LVC) or if you notice a reduction in power. If using a transmitter with a timer, set the timer so you have enough flight time to make several landing approaches.

Recharge the battery and repair the model as needed. The model's three point landing gear allows the model to land on hard surfaces. Align model directly into the wind and fly down to the ground. Fly the airplane down to the ground using 1/4-1/3 throttle to keep enough energy for proper flare. Before the model touches down, always fully decrease the throttle to avoid damaging the propeller or other components. The key to a great landing is to manage the power and elevator all the way to the ground and set down lightly on the main landing gear. After a few flights you will find the model can be set down lightly on the mains and you can hold the nose wheel off balancing the model on the mains till it slows and gently settles the nose.

Maintenance

Repairs to the foam should be made with foam safe adhesives such as hot glue, foam safe CA, and 5 min epoxy. When parts are not repairable, see the Spare Parts List for ordering by item number.

Always check to make sure all screws on the aircraft are tightened. Pay special attention to make sure the bullet of the rotor adaptor is firmly in place before every flight.

Troubleshooting

Problem	Possible Cause	Solution
Aircraft will not respond to the throttle but responds to other controls.	<ul style="list-style-type: none"> - ESC is not armed. - Throttle channel is reversed. 	<ul style="list-style-type: none"> - Lower throttle stick and throttle trim to lowest settings. - Reverse throttle channel on transmitter.
Extra propeller noise or extra Vibration.	<ul style="list-style-type: none"> - Damaged spinner, propeller, motor, or motor mount. - Loose propeller and spinner parts. - Propellor installed backwards. 	<ul style="list-style-type: none"> - Replace damaged parts. - Tighten parts for propeller adapter, propeller and spinner.
Reduced flight time or aircraft underpowered.	<ul style="list-style-type: none"> - Flight battery charge is low. - Propeller installed backward. - Flight battery damaged. 	<ul style="list-style-type: none"> - Remove and install propeller correctly. - Completely recharge flight battery. - Replace flight battery and obey flight battery instructions.
Control surface does not move, or is slow to respond to control inputs.	<ul style="list-style-type: none"> - Control surface, control horn, linkage or servo damage. - Wire damaged or connections loose. 	<ul style="list-style-type: none"> - Replace or repair damaged parts and adjust controls. - Do a check of connections for loose wiring.
Controls reversed.	Channels are reversed in the transmitter.	Do the Control Direction Test and adjust controls for aircraft and transmitter.
<ul style="list-style-type: none"> - Motor loses power. - Motor power pulses then motor loses power. 	<ul style="list-style-type: none"> - Damage to motor, or battery. - Loss of power to aircraft. - ESC uses default soft Low Voltage Cutoff(LVC). 	<ul style="list-style-type: none"> - Do a check of batteries, transmitter, receiver, ESC, motor and wiring for damage (replace as needed). - Land aircraft immediately and Recharge flight battery.
LED on receiver flashes slowly.	Power loss to receiver.	<ul style="list-style-type: none"> - Check connection from ESC to receiver. - Check servos for damage. - Check linkages for binding.

AMA

If you are not already a member of the AMA, please join, The AMA is the governing body of model aviation and membership provided liability insurance coverage, protects modelers' rights and interests and is required to fly at most R/C sites.

Academy of Model Aeronautics

5151 East Memorial Drive

Muncie, IN 47302-9252

Ph.(800)435-9262

Fax(765)741-0057

Or via the Internet at: <http://www.modelaircraft.org>

Academy of Model Aeronautics National Model Aircraft Safety Code Effective January 1, 2011

- A. GENERAL:** A model aircraft is a non-human-carrying aircraft capable of sustained flight in the atmosphere. It may not exceed limitations of this code and is intended exclusively for sport, recreation and/or competition.
All model flights must be conducted in accordance with this safety code and any additional rules specific to the flying site.
1. Model aircraft will not be flown:
 - (a) In a careless or reckless manner.
 - (b) At a location where model aircraft activities are prohibited.
 2. Model aircraft pilots will:
 - (a) Yield the right of way to all man carrying aircraft.
 - (b) See and avoid all aircraft and a spotter must be used when appropriate.
(AMA Document #540-D-See and Avoid Guidance.)
 - (c) Not fly higher than approximately 400 feet above ground level within three (3) miles of an airport, without notifying the airport operator.
 - (d) Not interfere with operations and traffic patterns at any airport, heliport or seaplane base except where there is a mixed use agreement.
 - (e) Ensure the aircraft is identified with the name and address or AMA number of the owner on the inside or affixed to the outside of the model aircraft.
(This does not apply to model aircraft flown indoors).
 - (f) Not operate aircraft with metal-blade propellers or with gaseous boosts except for helicopters operated under the provisions of AMA Document #555.
 - (g) Not operate model aircraft while under the influence of alcohol or while using any drug which could adversely affect the pilot's ability to safely control the model.
 - (h) Not operate model aircraft carrying pyrotechnic devices which explode or burn, or any device which propels a projectile or drops any object that creates a hazard to persons or property.

Exceptions:

- ◆ Free Flight fuses or devices that burn producing smoke and are securely attached to the model aircraft during flight.
- ◆ Officially designated AMA Air Show Teams (AST) are authorized to use devices and practices as defined within the Team AMA Program Document (AMA Document #718).
- 3. Model aircraft will not be flown in AMA sanctioned events, air shows or model demonstrations unless:
 - (a) The aircraft, control system and pilot skills have successfully demonstrated all maneuvers intended or anticipated prior to the specific event.
 - (b) An inexperienced pilot is assisted by an experienced pilot.
- 4. When and where required by rule, helmets must be properly worn and fastened. They must be OSHA, DOT, ANSI, SNELL or NOCSAE approved or comply with comparable standards.

B. RADIO CONTROL (RC)

1. All pilots shall avoid flying directly over unprotected people, vessels, vehicles or structures and shall avoid endangerment of life and property of others.
2. A successful radio equipment ground-range check in accordance with manufacturer's recommendations will be completed before the first flight of a new or repaired model aircraft.
3. RC model aircraft must use the radio-control frequencies currently allowed by the Federal Communications Commission (FCC). Only individuals properly licensed by the FCC are authorized to operate equipment on Amateur Band frequencies.
4. RC model aircraft will not operate within three (3) miles of any pre-existing flying site without a frequency-management agreement (AMA Documents #922-Testing for RF Interference; #923- Frequency Management Agreement)
5. With the exception of events flown under official AMA Competition Regulations, excluding takeoff and landing, no powered model may be flown outdoors closer than 25 feet to any individual, except for the pilot and the pilot's helper(s) located at the flight line.
6. Under no circumstances may a pilot or other person touch a model aircraft in flight while it is still under power, except to divert it from striking an individual. This does not apply to model aircraft flown indoors.
7. RC night flying requires a lighting system providing the pilot with a clear view of the model's attitude and orientation at all times.
8. The pilot of a RC model aircraft shall:
 - (a) Maintain control during the entire flight, maintaining visual contact without enhancement other than by corrective lenses prescribed for the pilot.
 - (b) Fly using the assistance of a camera or First-Person View (FPV) only in accordance with the procedures outlined in AMA Document #550.

C. FREE FLIGHT

1. Must be at least 100 feet downwind of spectators and automobile parking when the model aircraft is launched.
2. Launch area must be clear of all individuals except mechanics, officials, and other fliers.
3. An effective device will be used to extinguish any fuse on the model aircraft after the fuse has completed its function.



Email:info@fmsmodel.com
[Http://www.fmsmodel.com](http://www.fmsmodel.com)